

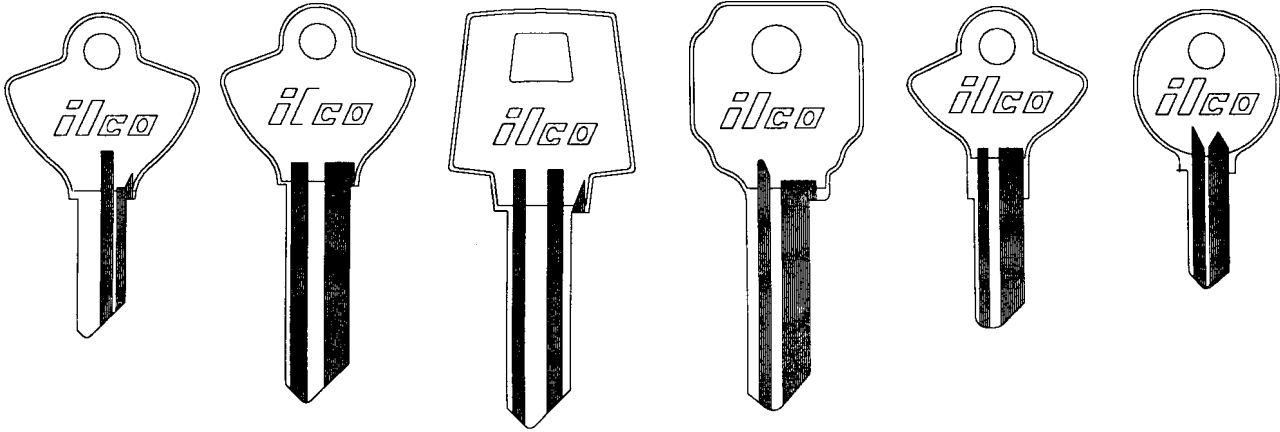



ILCO CYLINDER KEY BLANKS





R1096EN

S1096B



S1096C

S1096G

S1096JN

1154C

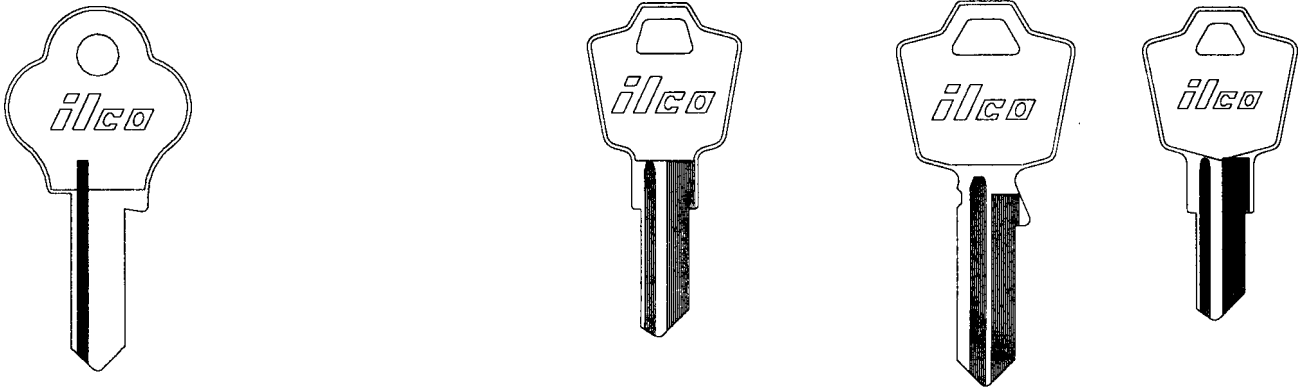
ELGIN



1528

1502

1502M Master

1503



1531

EMCO

ESP



1556

5 pin
6 pin

1054WB
A1054WB







A1114FM

5 pin
6 pin

1054WC (2)
A1054WC (1)

ESP

FALCON

ILCO CYLINDER KEY BLANKS

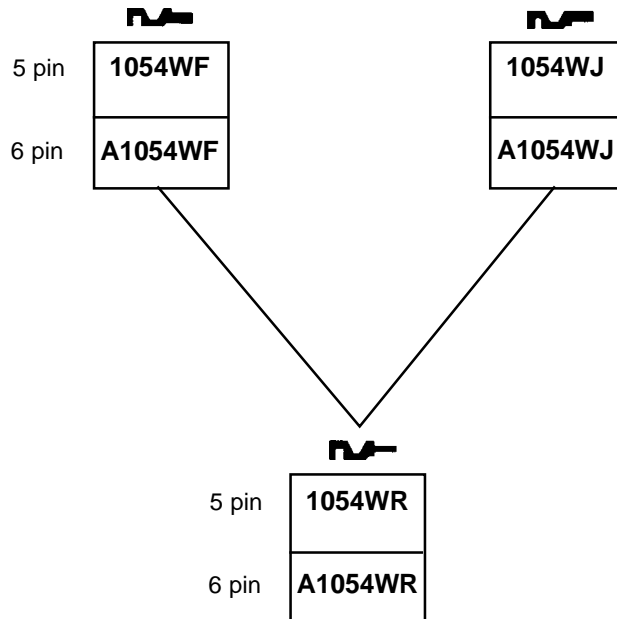
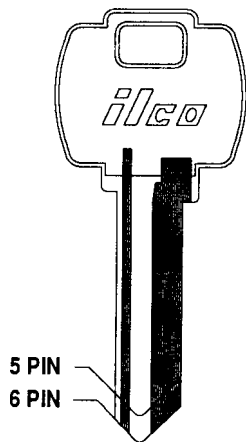
						
5 pin	1054WD (1)	1054WH	1054WK	1054WL	1054WN	1054WP
6 pin	A1054WD	A1054WH	A1054WK	A1054WL	A1054WN	A1054WP



FALCON

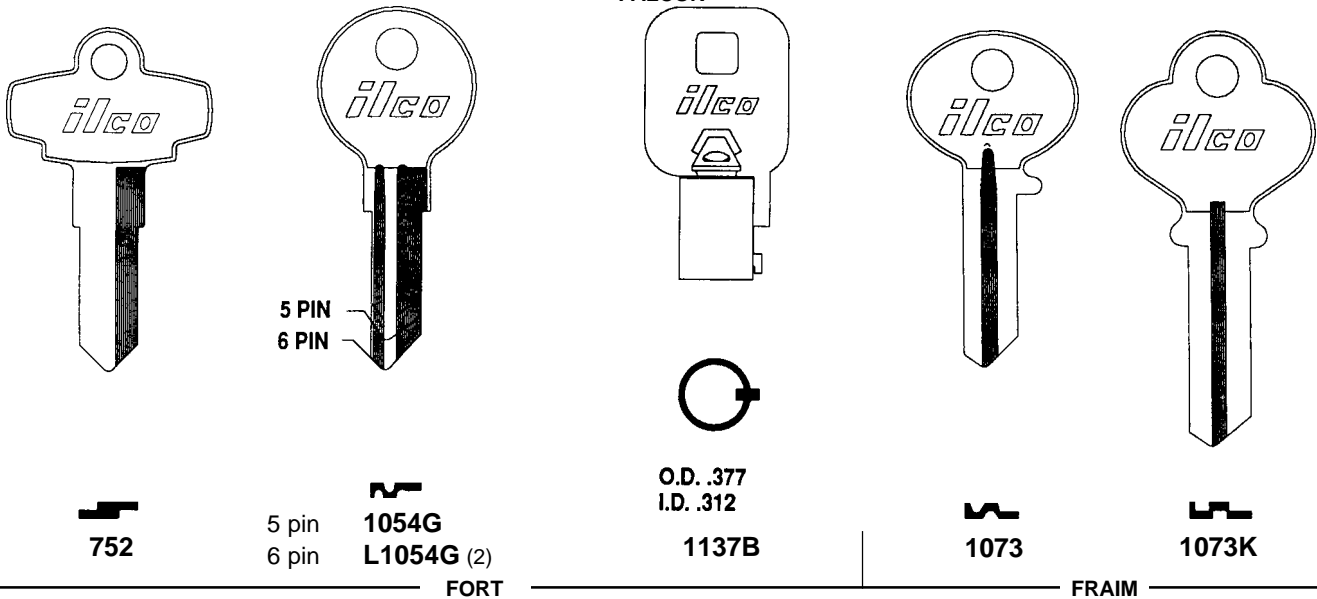

1 - Available in Look Alike, see pages 1070-1072.
 2 - Available in Taylor Line®, see page 1073.
 3 - Available in Bin Pack, see page 1074.

ILCO CYLINDER KEY BLANKS

LOOK-A-LIKE KEY BLANKS

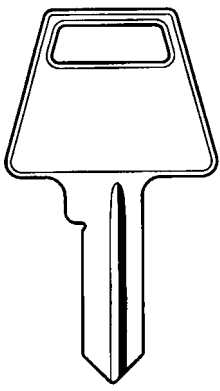

TA-PTKB1
AMERICAN

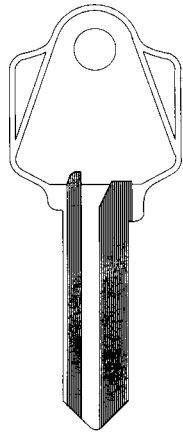

TA-K2A

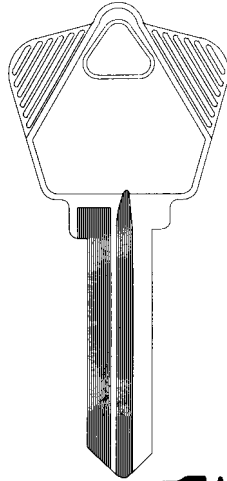

TA-K7

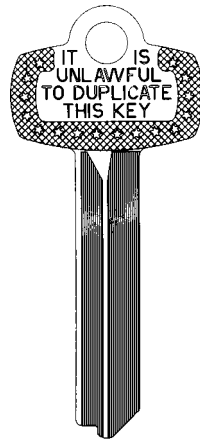

TA-1A1A1 NS



TA-1A1B1 NS



TA-1A1C1 NS



TA-1A1D1 NS



TA-1A1E1 NS



TA-1A1F1 NS



TA-1A1G1 NS



TA-1A1H1 NS



TA-1A1J1 NS



TA-1A1K1 NS



TA-1A1L1 NS



TA-1A1M1 NS



TA-1A1Q1 NS



TA-1A1R1 NS



TA-1A1FM1 NS*

*MASTER-Limited Applications

BEST

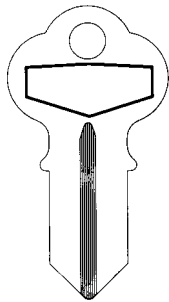

TA-K4

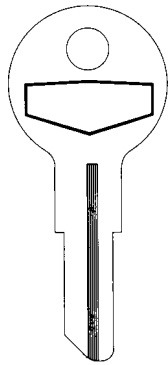

TA-K5

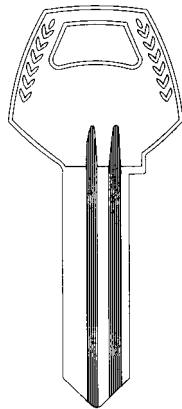

TA-Z1-59A1-6 NS



TA-Z1-59A2-6 NS



TA-Z1-59B1-6 NS



TA-Z1-59B2-6 NS

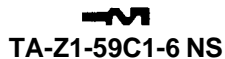

TA-Z1-59C1-6 NS



TA-Z1-59C2-6 NS



TA-Z1-59D1-6 NS



TA-Z1-59D2-6 NS

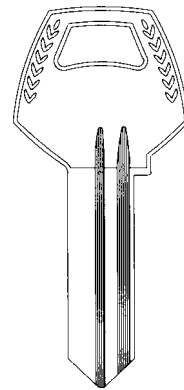

TA-Z1-60-5 NS

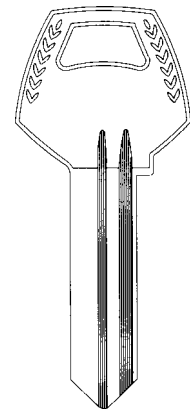

TA-Z1-60-6 NS

CHICAGO

CORBIN (NOW CORBIN/RUSSWIN)

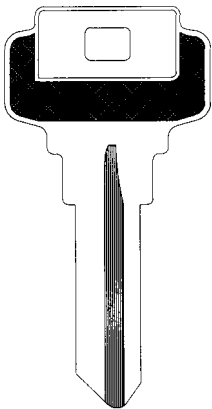

TA-67

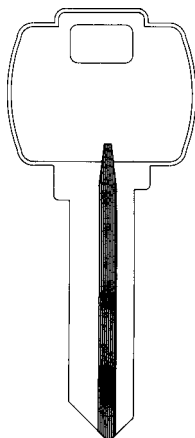

TA-P1577E NS

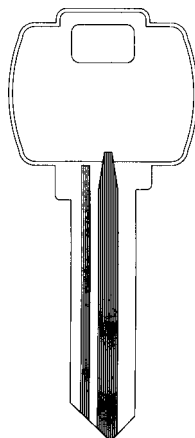

TA-KB1577G NS

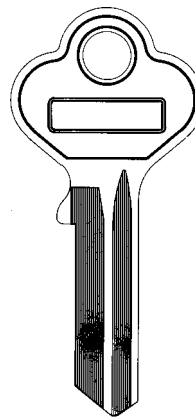

TA-HARLOC

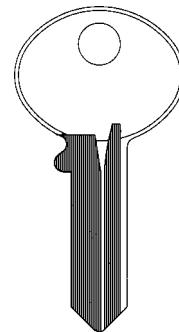

TA-H20

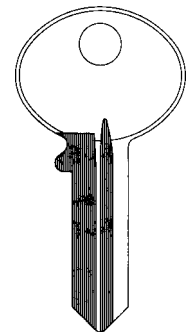

TA-H21







DEXTER/MASTER



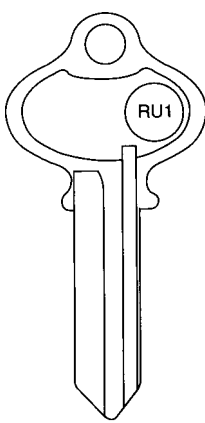
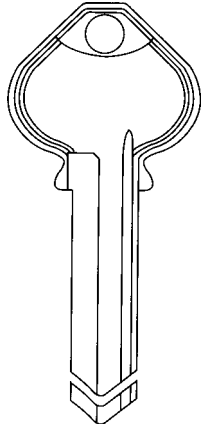
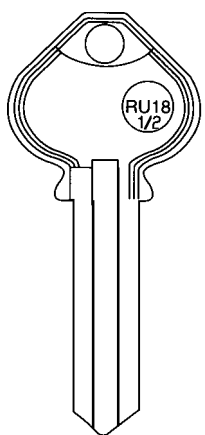
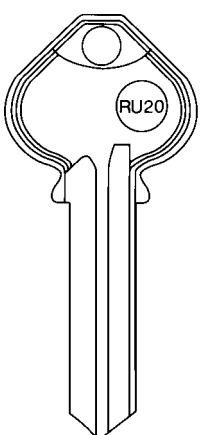
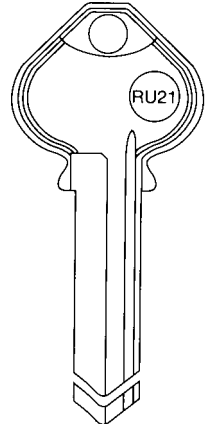
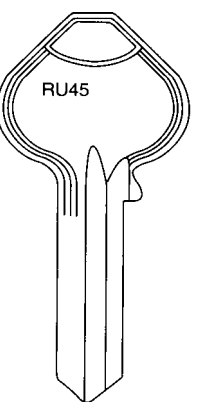



FALCON



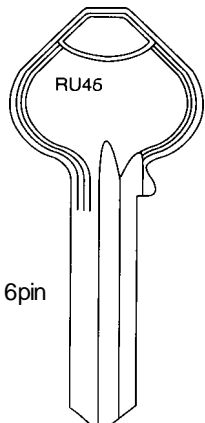
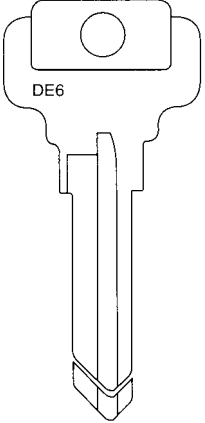
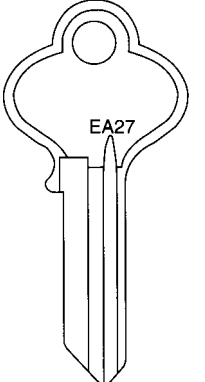
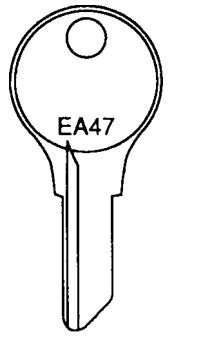
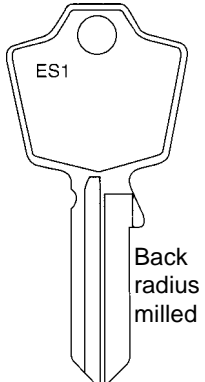



HARLOC

HUDSON

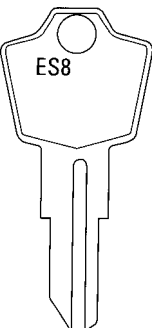
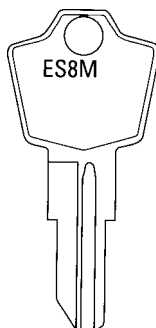
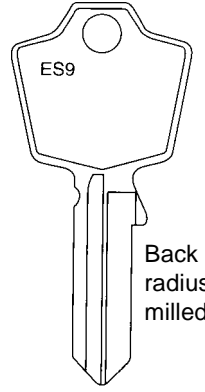
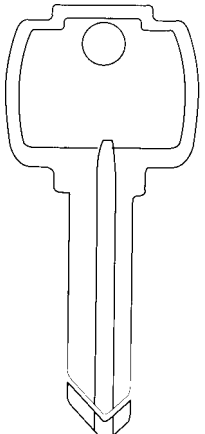
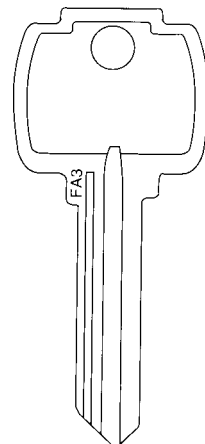
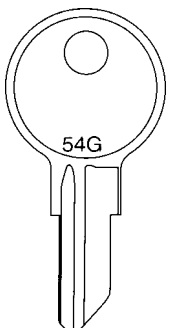
JET CYLINDER KEY BLANKS

 <p style="text-align: center;">RU1</p>		 <p style="text-align: center;">RU18 1/2</p>	 <p style="text-align: center;">RU20</p>	 <p style="text-align: center;">RU21</p>	 <p style="text-align: center;">RU45</p>
 JT-RU1	 5 pin JT-RU4 6 pin JT-RU16	 JT-RU18-1/2	 JT-RU20	 5 pin JT-RU21 6 pin JT-RU22	 JT-RU45 1 JT-RU45-250 (250 Blanks in Bulk Pack)
CORBIN/RUSSWIN					

 <p style="text-align: center;">RU46</p> <p style="text-align: center;">6pin</p>	 <p style="text-align: center;">DE6</p>	 <p style="text-align: center;">EA27</p>	 <p style="text-align: center;">EA47</p>	 <p style="text-align: center;">ES1</p> <p style="text-align: right;">Back radius milled</p>
 JT-RU46 1 JT-RU46-250 (250 Blanks in Bulk Pack)	 5 pin JT-DE6 1 JT-DE6-250 (250 Blanks in Bulk Pack)	 JT-EA27	 JT-EA47	 JT-ES1
CORBIN/RUSSWIN	DEXTER	EAGLE		ESP

 <p style="text-align: center;">ES8</p>	 <p style="text-align: center;">ES8M</p>	 <p style="text-align: center;">ES9</p> <p style="text-align: right;">Back radius milled</p>		 <p style="text-align: center;">FA3</p>	 <p style="text-align: center;">54G</p>
 JT-ES8	 JT-ES8M	 JT-ES9	 5 pin JT-FA1 6 pin JT-FA2	 JT-FA3	 JT-54G
ESP			FALCON		FORT

1 - Available in Uni Bow Head, see page 1090