

DOOR & CYLINDER GUARDS

LATCH PROTECTORS

The INTERLOCK for inswinging doors

<u>Stock No.</u>	<u>Size</u>	<u>Finish</u>
DJ-ILP206 SL	6"	Silver Coated
DJ-ILP206 DU	6"	Duro Coated
DJ-ILP206 BP	6"	Brass Plated
DJ-ILP212 SL	12"	Silver Coated
DJ-ILP212 DU	12"	Duro Coated
DJ-ILP212 BP	12"	Brass Plated

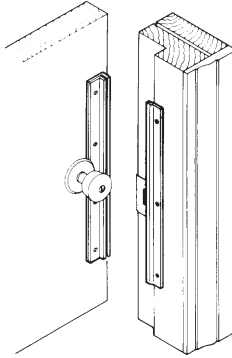

DON-JO

- 6" version for use with key-in-knob and deadbolt locks.
- 12" version for use with mortise locks, Simplex 1000 series, Alarm Lock DL-2500, DL-2700 & DL-3000, Card Access Systems, etc.
- 14 ga. (.075) Steel.

For Aluminum Entrance Doors

<u>Stock No.</u>	<u>Finish</u>
DJ-LP307 DU	Duro Coated
DJ-LP307 SL	Silver Coated

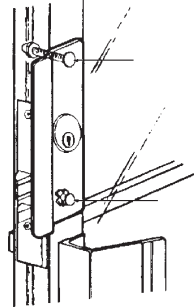

- Reversible.
- Fits over cylinder, lock removal NOT required.
- Hand carriage bolt and rivet supplied.
- No specific tools required.
- 3/8" offset.
- 2-5/8" x 7" x 1/8".
- 12 ga. (.104) Steel.

For Aluminum Entrance Doors - solves pull handle interference

<u>Stock No.</u>	<u>Finish</u>
DJ-GLP307 DU	Duro Coated

Specify Hand: LHR or RHR
(LHR shown in picture)

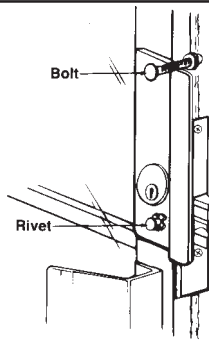

- **Handed: LHR or RHR.**
- Fits over cylinder, lock removal NOT required.
- Hand carriage bolt and rivet supplied.
- No specific tools required.
- 3/8" offset.
- 2-5/8" x 7" x 1/8".
- 12 ga. (.104) Steel.
- Center of cylinder hole is 2-1/2" from end of plate.

For Center Hung Outswinging Aluminum Doors

<u>Stock No.</u>	<u>Finish</u>	<u>Offset</u>
DJ-OLP2650DU	Duro Coated	1-1/8"
DJ-OLP2650SL	Silver Coated	1-1/8"
DJ-OLP2651DU	Duro Coated	1-3/8"
DJ-OLP2651SL	Silver Coated	1-3/8"

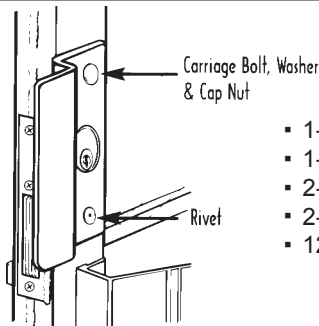

- 1-1/8" offset (OLP-2650).
- 1-3/8" offset (OLP-2651).
- 2-5/8" x 6-1/2" x 1/8" (OLP-2650).
- 2-5/8" x 6-1/2" x 3/8" (OLP-2651).
- 12 ga. (.104) Steel.

For Outswinging Doors - completely covers the strike plate

<u>Stock No.</u>	<u>Finish</u>
DJ-MLP111 630	Stainless Steel
DJ-MLP211 BP	Brass Plated
DJ-MLP211 DU	Duro Coated
DJ-MLP211 SL	Silver Coated

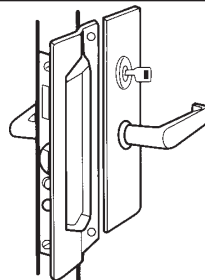

- Furnished with carriage bolts, washers & acorn nut for safety and strength.
- 3" x 11".
- 12 ga. (.104) Steel

©ZIPF LOCK COMPANY

DOOR & CYLINDER GUARDS

LATCH PROTECTORS

DON-JO

For Outswinging Doors - completely covers the strike plate

<u>Stock No.</u>	<u>Finish</u>
DJ-LP111 630	Stainless Steel
DJ-LP211 BP	Brass Plated
*DJ-9211 BP	Brass Plated
DJ-LP211 DU	Duro Coated
*DJ-9211 DU	Duro Coated
DJ-LP211 PC	Prime Coated
*DJ-9211 PC	Prime Coated
DJ-LP211 SL	Silver Coated

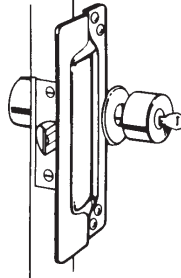

- Furnished with carriage bolts, washers & acorn cap nuts.
- 3" x 11"
- Fits 2-3/4" and 2-3/8" backsets.
- 12 ga. (.104) Steel.

***SAVE MONEY: DJ-9211 are poly-bagged and sold in multiples of 10.**

Pin Latch Protector for Outswinging Doors

<u>Stock No.</u>	<u>Finish</u>
DJ-PLP111 630	Stainless Steel
DJ-PLP211 BP	Brass Plated
DJ-PLP211 DU	Duro Coated
DJ-PLP211 SL	Silver Coated
DJ-PLP211 626	Satin Chrome



- Solid steel pin prevents spreading of door from frame.
- Pin is welded on back leaving no visible point of attack from outside.
- Extra Large cut out accepts **up to 3-1/2" rose.**
- Fits 2-3/4" and 2-3/8" backset.
- 3" x 11".
- 12 ga. (.104) Steel

Pin Latch Protector for Outswinging Doors

<u>Stock No.</u>	<u>Finish</u>
DJ-PMLP111 630	Stainless Steel
DJ-PMLP211 BP	Brass Plated
DJ-PMLP211 DU	Duro Coated
DJ-PMLP211 SL	Silver Coated

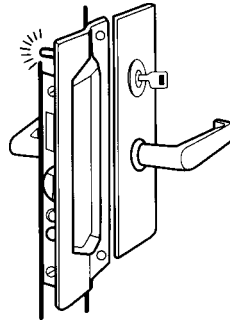

- Solid steel pin prevents spreading of door from frame.
- Pin is welded on back leaving no visible point of attack from outside.
- Fits 2-3/4" and 2-3/8" backset.
- 3" x 11".
- 12 ga. (.104) Steel

For Outswinging Doors

<u>Stock No.</u>	<u>Finish</u>
DJ-LP107 630	Stainless Steel
DJ-LP207 BP	Brass Plated
DJ-LP207 SL	Silver Coated
DJ-LP207 DU	Duro Coated



- Furnished with carriage bolts, washers & acorn cap nuts.
- 2-3/4" x 7"
- 12 ga. (.104) Steel

Commercial Type For Outswinging Doors

<u>Stock No.</u>	<u>Finish</u>	<u>Dimensions</u>
DJ-CLP106 630	Stainless Steel	2-1/8" x 6"
DJ-CLP110 630	Stainless Steel	2-1/8" x 10"

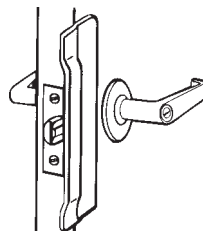

- 6" for key-in-knobs.
- 10" for mortise locks.
- Architectural design.
- Concealed welded studs with fasteners.
- 12 ga. (.104) Steel

©ZIPF LOCK COMPANY

DOOR & CYLINDER GUARDS

LATCH PROTECTORS

DON-JO

Narrow Commercial Type For Outswinging Doors

<u>Stock No.</u>	<u>Size</u>	<u>Finish</u>
DJ-NLP106 630	6"	Stainless Steel
DJ-NLP206 DU	6"	Duro Coated
DJ-NLP206 PC	6"	Prime Coated
DJ-NLP206 SL	6"	Silver Coated
DJ-NLP110 630	10"	Stainless Steel
DJ-NLP210 DU	10"	Duro Coated
DJ-NLP210 PC	10"	Prime Coated
DJ-NLP210 SL	10"	Silver Coated



- 6" for key-in-knob.
- 10" for mortise locks.
- Narrow type for outswinging doors.
- NLP106: 1-1/2" x 6"
- NLP110: 1-1/2" x 10"
- NLP206: 1-1/2" x 6"
- NLP210: 1-1/2" x 10"
- 12 ga. (.104) Steel.

For Key-In-Lever with up to 3-3/4" escutcheon

<u>Stock No.</u>	<u>Finish</u>
DJ-BLP107 630	Stainless Steel
DJ-BLP207 BP	Steel Brass Plated
DJ-BLP207 DU	Duro Coated
DJ-BLP207 SL	Silver Coated

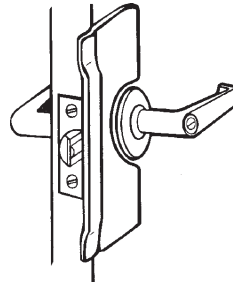

- Works with up to 3-3/4" rose.
- Fits most heavy duty key-in-lever locks.
- Concealed welded studs and fasteners.
- 3-1/4" x 7".
- 12 ga. (.104) Steel.

For Electronic Locks

<u>Stock No.</u>	<u>Finish</u>
DJ-KLP110 LH 630	Stainless Steel
DJ-KLP110 RH 630	Stainless Steel

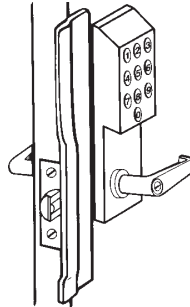

- Works with ILCO 1000, 4000 locks.
- Alarm Lock Trilogy locks.
- Mas-Hamilton Power Levers.
- Schlage Cobra locks.
- 1-1/2" x 10".
- 12 ga. (.104) Steel.

Angle Type for Outswinging Doors

<u>Stock No.</u>	<u>Size</u>	<u>Finish</u>
DJ-ALP206 BC	6"	Brass Coated
DJ-ALP206 DU	6"	Duro Coated
DJ-ALP206 SL	6"	Silver Coated
DJ-ALP210 BC	10"	Brass Coated
DJ-ALP210 DU	10"	Duro Coated
DJ-ALP210 SL	10"	Silver Coated

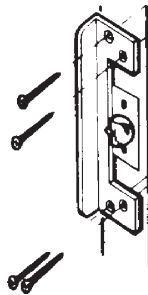

- 6" for key-in-knob.
- 10" for mortise locks.
- 1-1/2" sheet metal screws for wood or metal.
- 10 ga. (.134) Steel

For use with Electric Strikes

<u>Stock No.</u>	<u>Finish</u>
DJ-ELP208 DU	Duro Coated
DJ-ELP208 SL	Silver Coated
DJ-ELP208P DU*	Duro Coated
DJ-ELP208P SL*	Silver Coated

*Without cylinder hole.

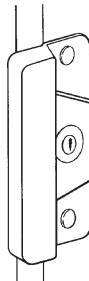

- Available with or without cylinder hole.
- Designed to fit most electric strikes.
- Completely encases the keeper for maximum protection.
- 3-1/2" x 8".
- 12 ga. (.104) Steel.

©ZIPF LOCK COMPANY

DOOR & CYLINDER GUARDS

LATCH PROTECTORS

DON-JO

Fits Folger Adams Electric Strike - for outswinging doors.

Stock No.

DJ-FLP211 SL

Finish

Silver Coated

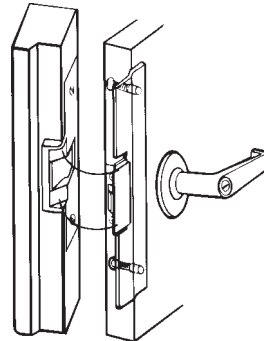

- Works with Folger Adams 310 & 710.
- 1-3/4" x 11-1/4".
- 12 ga. (.104) Steel.

Short Type for Outswinging Doors

Stock No.

DJ-SLP206 BP

Finish

Brass Plated

DJ-SLP206 SL

Silver Coated

DJ-SLP206 DU

Duro Coated

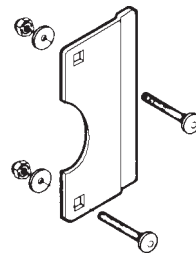

- Furnished with carriage bolts, washers & acorn cap nuts for safety & strength.
- May be used on hollow metal door/frame using ANSI strike.
- Works with up to 3-3/4" rose.
- 2-1/2" x 6"
- 12 ga. (.104) Steel

Slimline for Outswinging Doors

Stock No.

DJ-LP2878 DU

Finish

Duro Coated

DJ-LP2878 PC

Prime Coated

DJ-LP2878 SL

Silver Coated



- Fasteners Included.
- Sleek Appearance.
- 1-1/2" x 8-7/8" x 5/16".
- 5/16" thick (.3125) Steel.

Fits Adams Rite Latch Lock for outswinging doors

Stock No.

DJ-LP312 DU

Finish

Duro Coated

DJ-LP312 SL

Silver Plated

DJ-LP312P DU*

Duro Coated

DJ-LP312P SL*

Silver Coated

* No Center Hole

DJ-LP312P supplied without 1-7/16" hole. Allows installer to drill hole for custom applications.

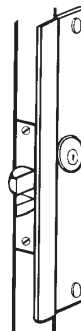

- Reversible.
- 1/4" Offset.
- 1-7/16" Hole (also available w/o hole).
- 1-1/8" Backset.
- 2-5/8" X 12" X 1/8".
- 12 ga. (.104) Steel.

Your warehouse around the corner!!!

DOOR & CYLINDER GUARDS

ALUMINUM DOOR SECURITY



STYLE GUARD—K-9/K-21

Made of 12 gauge steel, Style Guard reinforces or repairs aluminum-style doors. 8" long. KD-K-9 for standard 4" jamba and KD-K-21 for 4-1/2" jamba. Designed with a "knock-out" to accommodate either the W&F or the Adams Rite bolt. Baked on enamel-type finish matches nicely for a professional looking job.

Stock No.	Length	Finish
KD-K-9A 626	4"	Aluminum Finish
KD-K-9B 613	4"	Duronotic Finish
KD-K-21A 626	4-1/2"	Aluminum Finish
KD-K-21B 613	4-1/2"	Duronotic Finish

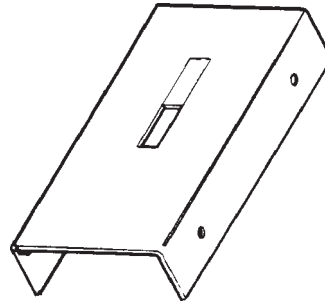

DOUBLE DOOR STYLE GUARD—K-15

Finally a better way to secure a set of double aluminum doors!! 12 gauge steel increases security and can repair doors that have already been attacked. 7-3/4" long, for 1-3/4" doors. Designed with knock out feature to make a W&F into an Adams Rite

Stock No.	Finish
KD-K-15A 626	Aluminum Finish
KD-K-15B 613	Duronotic Finish

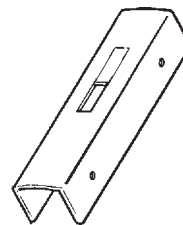

OFFSET STYLE GUARD—K-20

To complete our style guard line we finally have a guard for the offset aluminum door or doors that swing one way with jamb stops. 7" long. This non-handed guard is easy to install and comes with pop rivets and carriage bolts.

Stock No.	Finish
KD-K-20A 626	Aluminum Finish
KD-K-20B 613	Duronotic Finish

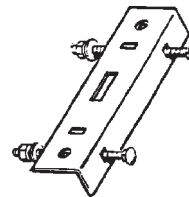

CYLINDER GUARD RING—K-24

Hardened steel, free spinning, tapered cone shaped cylinder guard. Works with both 5 and 6 pin cylinders. Kit includes 6 of each: ring, stainless steel wave washer and spacing collar.

Stock No.	Finish
KD-K-24A 626	Aluminum Finish
KD-K-24B 613	Duronotic Finish

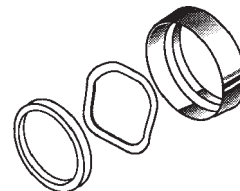

PROTECT-A-LOK—K-12

Finally a product designed to protect locks from impact damage. The Keedex KD-K-12 Protect-A-Lok, made from U.L. approved Lexan plastic, is virtually indestructible by impact. Designed for use in areas where locks may have a chance of getting hit by carts, forklifts or moving vehicles. Can be used with levers, knobs or panic hardware with any size backset. Installs in minutes. Guaranteed for 5 years.

Stock No.	Finish
KD-K-12	Cream Finish
KD-K-12D	Duronotic Finish

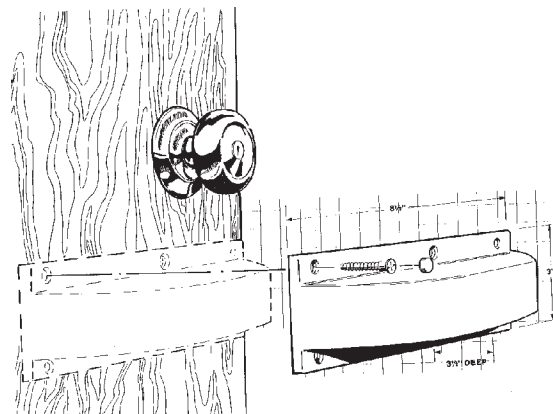

Ideal for Super Markets, Warehouses, Hotels, Hospitals, Restaurants and more.

©ZIPF LOCK COMPANY

DOOR & CYLINDER GUARDS

HEAVY DUTY GUARD PLATE



VDG-10

The VDG-10 is the strongest and most popular guard plate. It is 14" long and is made from 2 pieces of 16 gauge cold rolled steel, welded together with a baked Matte Bronze finish.

This guard plate offers maximum resistance to prying and forcing. It mounts onto your door with 2 carriage bolts going through the door and anchored with a nut and cap nut on the inside. Four wood screws go into the edge of the door. Guard plates come complete with all necessary hardware and illustrated instructions.

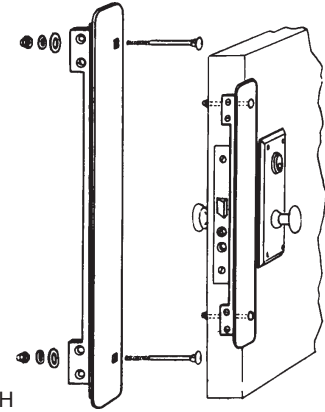

1-3/4"W x 14"H

PROTECT AGAINST
BREAK-INS!!

LATCH-GARD®

Finishes:

- BB- Bright Brass
- D- Duranodic
- Z- Zinc Plated



3" x 11"
LG-100

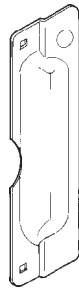

3" x 11"
LG-110



1-1/2" x 6"
LG-120



1-1/2" x 10"
LG-130



2-1/2" x 10"
LG-140



2-5/8" x 6"
LG-150

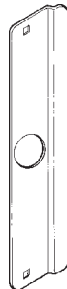

12" x 2-5/8"
Fits Adams Rite
LG-160

1-7/8" x 12"

LG-170
3/8" offset

LG-171
1/2" offset

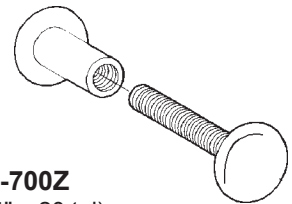

LG-700Z
(1/4" x 20 tpi)
with screw

LG-710Z
(5/16" x 18 tpi)
with screw

TO ORDER: Specify Guard No. and Finish.

LG-100 + BB = LG-100-BB

DOOR & CYLINDER GUARDS



LORI

"THE BLOCKER"

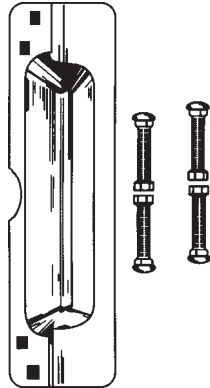

Discontinued.
Call for closeout prices

"THE SUPER BLOCKER" FOR ALUMINUM DOORS

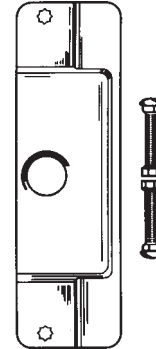

Application: The Blocker® discourages forced entry attempts on outswinging doors. 3" x 10-7/8"

Stock No. **Finish**
\$LOR-1100 DU Duranodic

Application: The Super Blocker® is designed for narrow style aluminum doors. Reversible. Complete with 2 sex nuts. 3-1/2" x 12"

Stock No. **Finish**
\$LOR-1120 AL Aluminum

CAL-ROYAL

CR-LPG2
Latch Guard
Finishes:
ALUM, DURO,
GOLD, USP

2-7/8" x 11"



Stock No. **Finishes**
MAG-8840-B Brass
MAG-8840-C Chrome

Latch Guard 7", for In-Opening doors. All backsets, Deadbolts and Key-in-knobs locks. Reinforces door and frame, prevents spreading of frame, hardened conealed screws. 14GA. U.S. Pat. 5,395,145

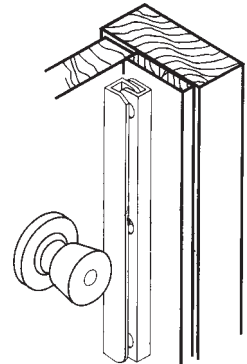

Stock No. **Finishes**
MAG-8843-B Brass
MAG-8843-C Chrome

Latch Guard 12", for In-Opening doors. All backsets, Deadbolts and Key-in-knobs locks. Double locks, Mortise Locks & Access control locks. Reinforces door and frame, prevents spreading of frame, hardened conealed screws. 14GA. U.S. Pat. 5,395,145

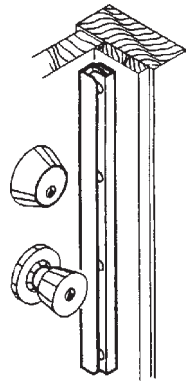

Stock No. **Finishes**
MAG-8845-B Brass
MAG-8845-C Chrome

Latch Guard 6", for Out-Opening doors. All backsets, Deadbolts and Key-in-knobs locks. Protects latch or bolt, heavy gauge steel. Accepts up to 3-1/2" rose, 7/16" offset. 12 GA.

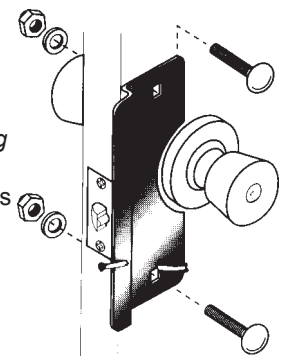

DOOR & CYLINDER GUARDS



Stock No. **Finishes**
MAG-8848-B Brass
MAG-8848-C Chrome

Latch Guard Heavy Duty 7", for Out-Opening doors. All backsets, Deadbolts and Key-in-knobs locks. Protects latch or bolt. Conceals lip if existing strike. Accepts up to 3-1/2" rose. 12 GA.

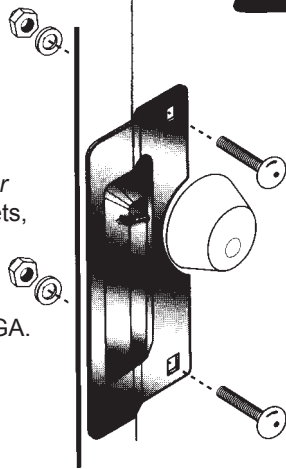

Stock No. **Finishes**
MAG-8850-B Brass
MAG-8850-C Chrome

Latch Guard Universal 11-3/4", for Out-Opening doors with 1" x 8-3/4" Cutout. All backsets, single locks, double locks up to 6" on center, combination locks, mortise locks & access control locks. Protects latch and bolt, conceals lip of existing strike. Reinforced mounting area. 12GA. with anti-spread pin. U.S. Pat. 5,415,020.

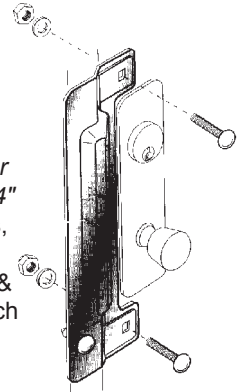

Stock No. **Finishes**
MAG-8852-AL Aluminum
MAG-8852-DU Duronodic

Latch Guard 6-1/2", for Out-Opening doors. Narrow stile, store front doors with cylinder guard and drive rivet, 3/16" offset with 1/2" clearance under channel. 12GA.

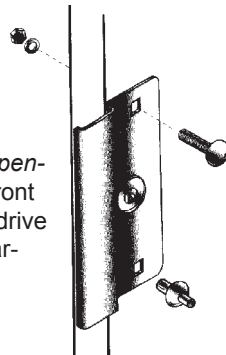

Stock No. **Finishes**
MAG-8854-AL Aluminum
MAG-8854-DU Duronodic

Latch Guard 12", Removable (for flush doors). With anti-spread pins for single or double acting doors with cylinder guard. 12GA. U.S. Pat. 5,547,239.

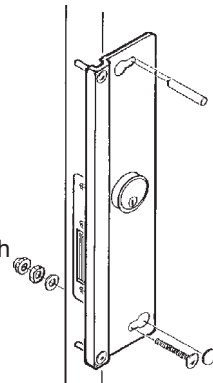

Stock No. **Finishes**
MAG-8855-AL Aluminum
MAG-8855-DU Duronodic

Latch Guard 12", Removable (for center hung 4" frame). With anti-spread pins for center hung doors, 1-1/8" offset for 4" frame with cylinder guard, for single or double acting. 12GA. U.S. Pat. 5,547,239.

