

ARROW

12 locks per case.

HEAVY DUTY-H Series

- ANSI A156.2, Series 4000, Grade 1
- Conforms to Fed. Specs FFH-106C, Type 161
- U.L. Listed for "A" labeled or lesser doors
- For Heavy Duty Commercial



SPECIFICATIONS

DOOR THICKNESS: 1-3/8" to 2"
BACKSET: 2-3/4" Square Corner 1-1/8" wide face
BORE: 2-1/8" x 1"
ROSE: 3-1/4"
KEYWAY: Arrow "A" drilled for 6
FINISHES: **US-26D** Satin Chrome

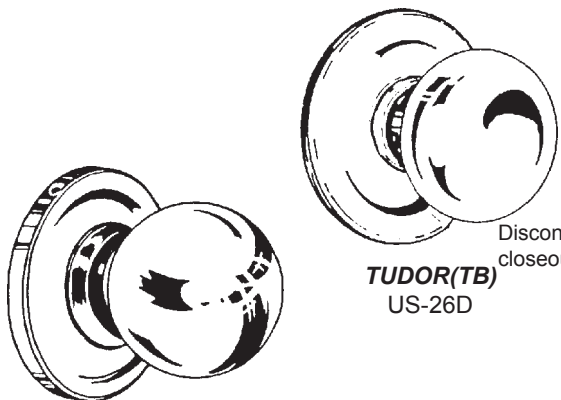

BALL(BB)
US-26D

TUDOR(TB)
US-26D

Discontinued-Call for closeout prices

To Order, Specify:

Function: **H11** Entrance
 Design: **TB** Tudor
 Finish: **US-26D** Satin Chrome

H11TB-IC US-26D

Not all functions are available in all designs/finishes

Function	Knob No.	Lever No.	Operation
ENTRANCE	H11	Q11	Latch by knob/lever either side except when pushing turn button locks outside knob/lever. Unlocked by turning inside knob/lever or using key outside. Turning inside button keeps outside knob/lever locked. Key will retract latch.
STOREROOM	H12	Q12	Latch by inside knob/lever. Outside knob/lever always rigid. Key will retract latch.
CLASSROOM	H17	Q17	Latch by knob/lever either side except when key locks outside knob/lever. Key will unlock knob/lever.

HEAVY DUTY-Q Series

- ANSI A156.2, Series 4000, Grade 1
- ANSI A117.1 Accessibility Code
- Conforms to Fed. Specs FFH-106C, Type 161
- U.L. Listed for "A" labeled or lesser doors
- For Heavy Duty Commercial

Discontinued - call for closeout prices

12 locks per case.

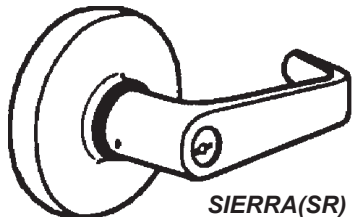

SIERRA(SR)
US-26D

SPECIFICATIONS

DOOR THICKNESS: 1-3/4" to 2"
BACKSET: 2-3/4" Square Corner 1-1/8" wide face
BORE: 2-1/8" x 1"
ROSE: 3-5/16"
KEYWAY: Furnished Less Cylinder.
FINISHES: **US-26D** Satin Chrome

To Order, Specify:

Function: **Q11** Entrance
 Design: **SR** Sierra
 Finish: **US-26D** Satin Chrome
 Cylinder: **-LC*** Less Cylinder

**Stocked LESS CYLINDER (LC). Specify when ordering if cylinder is required*

ARROW

12 locks per case.

HEAVY DUTY-H Series INTERCHANGEABLE CORE

- ANSI A156.2, Series 4000, Grade 1
- Conforms to Fed. Specs FFH-106C, Type 161
- U.L. Listed for "A" labeled or lesser doors
- For Heavy Duty Commercial



SPECIFICATIONS

DOOR THICKNESS: 1-3/8" to 2"
BACKSET: 2-3/4"
BORE: 2-1/8"
ROSE: TB: 3-1/4"
FINISHES: **US-26D** Satin Chrome

To Order, Specify:

Function: **H11** Entrance
 Design: **TB** Tudor
 -IC Interchangeable Core
 Finish: **US-26D** Satin Chrome

H11TB-IC US-26D

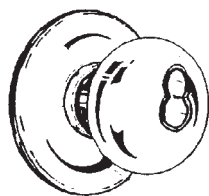

TUDOR(TB)
US-26D

Function	Knob No.	Lever No.	Operation
ENTRANCE	H11TB-IC	Q11SR-IC	Latch by knob/lever either side except when pushing turn button locks outside knob/lever. Unlock by turning inside knob/lever or using key outside. Turning inside button keeps outside knob/lever locked. Key will retract latch.
STOREROOM	H12TB-IC	Q12SR-IC	Latch by inside knob/lever. Outside knob/lever always rigid. Key will retract latch.

HEAVY DUTY-Q Series INTERCHANGEABLE CORE

- ANSI A156.2, Series 4000, Grade 1
- ANSI A117.1 Accessibility Code
- Conforms to Fed. Specs FFH-106C, Type 161
- U.L. Listed for "A" labeled or lesser doors
- For Heavy Duty Commercial

12 locks per case.

SPECIFICATIONS

DOOR THICKNESS: 1-3/8" to 2"
BACKSET: 2-3/4"
BORE: 2-1/8"
ROSE: TB: 3-1/4"
FINISHES: **US-26D** Satin Chrome



To Order, Specify:

Function: **Q11** Entrance
 Design: **SR** Sierra
 -IC Interchangeable Core
 Finish: **US-26D** Satin Chrome

Q11SR-IC US-26D

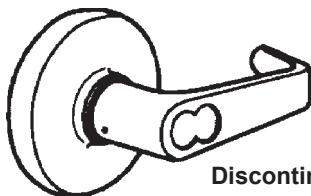

SIERRA(SR)
US-26D

Discontinued-Call for closeout prices

NOTE: Locks do not come with cores and must be ordered SEPARATELY. Locks will accept Arrow, Best and Falcon 7 pin cores. To use a 6 pin core you must order AR-CH6-44 or AR-CL69-44 (6 pin tailpiece assembly)

6-PIN TAILPIECE ASSEMBLIES

AR-CH6-44 6 pin tailpiece assembly for "H" Series IC

AR-CL69-44 6 pin tailpiece assembly for "Q" Series IC

UNCOMBINATED CORES

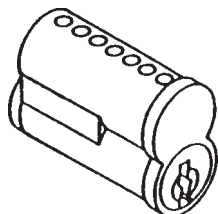

Stock No. **Description**
AR-C6S-UC- 6 pin core
AR-C7S-UC- 7 pin core

Keyways stocked:
 ARROW: **1D**
 BEST: **AB, BB, DB, EB, FB, GB, HB, JB, KB, MB**

TO ORDER CORE, SPECIFY: Stock No. + Keyway Code + Finish = AR-C7S-UC-AB 26D

©ZIPF LOCK COMPANY

ARROW

STANDARD DUTY-M Series

- ANSI A156.2, Series 4000, Grade 2
- Standard Duty For Light Commercial
- Sierra-Medium Duty Lock Built On Heavy Duty Chassis



24 locks per case.
Lever-12 locks.

ANSI A117.1
Accessibility Code



Call for availability. Some locks are discontinued.

Thru-bolted within
161 prep

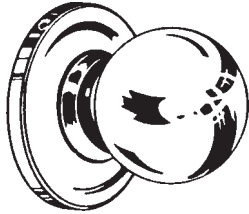

BALL(BD)
US-3, 26D

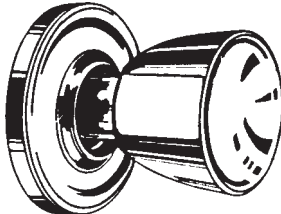

DARRIN(DD)
US-3, 5A, 26D

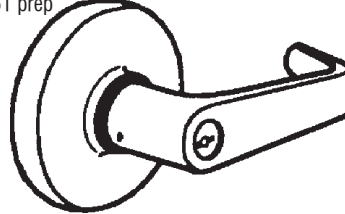

SIERRA(SR)
US-3, 26D
2-3/4" only U.L. Listed

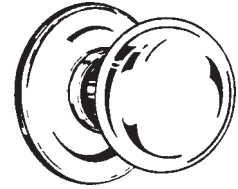

TUDOR(TA)
US-3, 5A, 26D

<u>Function</u>	<u>Knob No.</u>	<u>Lever No.</u>	<u>Operation</u>
PASSAGE	MK01	ML01	Latch by knob/lever either side.
PRIVACY	MK02	ML02	Latch by knob/lever either side except when inside push button locks outside knob/lever. Unlocked by turning inside knob/lever, closing door or turning outside emergency slot.
DUMMY	MK08	—	1/2 dummy trim (no latch).
ENTRANCE	MK11	ML11	Latch by knob/lever either side except when pushing turn button locks outside knob/lever. Unlock by turning inside knob/lever or using key outside. Pushing and Turning inside button keeps outside knob/lever locked. Key will retract latch.
STOREROOM	MK12	ML12	Latch by inside knob/lever only. Outside knob/lever always rigid. Key will retract latch.
CLASSROOM	MK17	ML17	Latch by knob/lever either side except when key locks outside knob/lever. Key will unlock knob/lever.
COMMUNICATING	MK31	ML31	Latch by knob/lever either side except when key locks its own knob/lever.
PUBLIC ENTRANCE	MK32	ML32	Latch key knob/lever either side except when outside knob/lever is locked by inside key. Outside key will retract latch.
FIXED KNOBS	MK33	ML33	Both knobs/levers always rigid. Either key will retract latch.

To Order, Specify:

Function: **MK11** Entrance
 Design: **TA** Tudor
 Finish: **US-26D** Satin Chrome
 Latch: **234** 2-3/4" Backset

Not all functions are available in all designs/finishes
CS-Some locks available with "C" keyway, suffix **-CS**

SPECIFICATIONS

DOOR THICKNESS: 1-3/8" to 1-3/4"
BACKSET: 2-3/8", 2-3/4"
BORE: 2-1/8" x 7/8"
ROSE: 3-1/2" for Sierra
 2-9/16" for balance
KEYWAY: Arrow "A" drilled for 6
 (pinned for 5)
FINISHES: **US-3** Polished Brass
US-5A Antique Brass
US-26D Satin Chrome

NOTE: Unless otherwise specified 2-3/8" square face latch is standard. Specify DI for drive in. The Sierra is 2-3/4" backset U.L. listed only. Many of the locks are available with 2-3/4" UL Listed deadlatch or ASA strike...Call.

ARROW™

24 locks per case.

STANDARD DUTY-M Series INTERCHANGEABLE CORE

- ANSI A156.2, Series 4000, Grade 2
- For Light Commercial

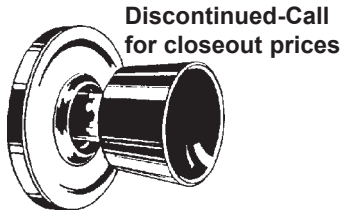

DARRIN(DD)
US-26D

Discontinued-Call
for closeout prices

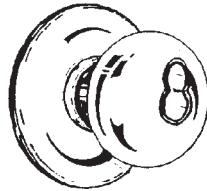

TUDOR(TA)
US-26D

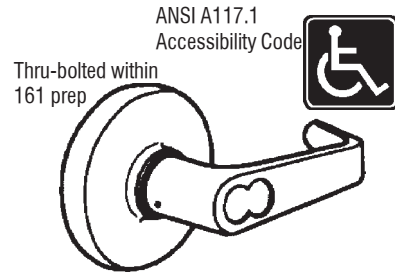

SIERRA(SR)
US-26D
2-3/4" only U.L. Listed

Function	Knob No.	Lever No.	Operation
ENTRANCE	MK11__-IC	ML11SR-IC	Latch by knob/lever either side except when pushing turn button locks outside knob/lever. Unlock by turning inside knob/lever, or using key outside. Turning inside button keeps outside knob/lever locked. Key will retract latch.
STOREROOM	MK12__-IC	ML12SR-IC	Latch by inside knob/lever only. Outside knob/lever always rigid. Key will retract latch.
CLASSROOM	MK17__-IC	ML17SR-IC	Latch by knob/lever either side except when key locks outside knob/lever. Key will unlock knob/lever.

To Order, Specify:

Function: **MK11** Entrance
 Design: **TA** Tudor
 -IC Interchangeable core
 Finish: **US-26D** Satin Chrome
 Latch: **234** 2-3/4" Backset
Not all functions are available in all designs/finishes

SPECIFICATIONS

DOOR THICKNESS: 1-3/8" to 1-3/4"
BACKSET: 2-3/4"
BORE: 2-1/8"
ROSE: 3-1/2" for Sierra
 2-9/16" for balance
FINISHES: **US-26D** Satin Chrome

NOTE: Locks do not come with cores and must be ordered SEPARATELY. Locks will accept Arrow, Best and Falcon 7 pin cores. To use a 6 pin core you must order AR-CH6-44 or AR-CL69-44 (6 pin tailpiece assembly)

6-PIN TAILPIECE ASSEMBLIES

AR-CM6-44 6 pin tailpiece assembly for "MK" Series IC

AR-CL6-44 6 pin tailpiece assembly for "ML" Series IC

UNCOMBINED CORES

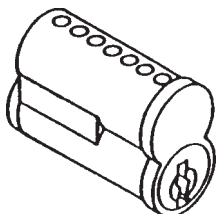

Stock No. **Description**
AR-C6S-UC- 6 pin core
AR-C7S-UC- 7 pin core

Keyways stocked:
 ARROW: 1D
 BEST: AB, BB, DB, EB, FB, GB, HB, JB, KB, MB

TO ORDER CORE, SPECIFY: Stock No. + Keyway Code + Finish = AR-C7S-UC-AB 26D

©ZIPF LOCK COMPANY

ARROW

LIGHT DUTY-L Series

- ANSI A156.2, Series 4000, Grade 2
- ANSI A117.1 Accessibility Code
- U.L. Listed For 3 Hour, A Label Doors
- Light Commercial For Interior Doors
- Ideal For Commercial Applications Where Heavy-Duty Grade Levers May Not Be Required



12 locks per case.

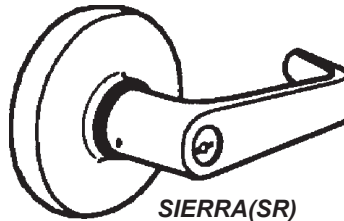

SIERRA(SR)
US-26D



Discontinued-Call for closeout prices

<u>Function</u>	<u>No.</u>	<u>Operation</u>
PASSAGE	L01	Latch by lever either side.
PRIVACY	L02	Latch by lever either side except when inside push button locks outside lever. Unlocked by turning inside lever, closing door or turning outside emergency slot.
ENTRANCE	L11*	Latch by lever either side except when pushing turn button locks outside lever. Unlocked by turning inside lever or using key outside. Pushing and Turning inside button keeps outside lever locked. Key will retract latch.
STOREROOM	L12*	Latch by inside lever. Outside lever always rigid. Key will retract latch.
CLASSROOM	L17*	Latch by lever either side except when key locks outside lever. Key will unlock lever.

To Order, Specify:

Function: **L11** Entrance
 Design: **SR** Sierra
 Finish: **US-26D** Satin Chrome
 Cylinder: **-LC*** Less Cylinder

**Stocked LESS CYLINDER (LC). Specify when ordering if cylinder is required*

SPECIFICATIONS

DOOR THICKNESS: 1-3/8" to 1-3/4"
BACKSET: 2-3/4" Square Corner 1-1/8" wide Face. U.L. Listed
BORE: 2-1/8" x *7/8"
 *Latch sleeve supplied for 1"
ROSE: 3-5/16"
KEYWAY: Less Cylinder, Specify if cylinder is required.
FINISHES: **US-26D** Satin Chrome

CAL-ROYAL

10 locks per case

GENESYS SERIES GRADE 1

CAL-ROYAL

Extra Heavy Duty Cylindrical Leverset

- ANSI A156.2 Series 4000, Grade 1.
- U.L. Listed for 3 Hour Doors.
- Patented Free Turning Handle in Locked Position.
- 1-year Mechanical Warranty.
- Non-Handed.
- Levers BOTH Sides.
- Thru-bolted Assembly With Separate Spring Cage For Each Lever.
- Solid Brass 6-pin Cylinder. "C" Keyway.
- Also Available in Interchangeable Core.

Meets ADA requirements. Specially designed for Barrier Free Applications. Meets A117.1 Accessibility Code.

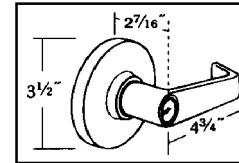
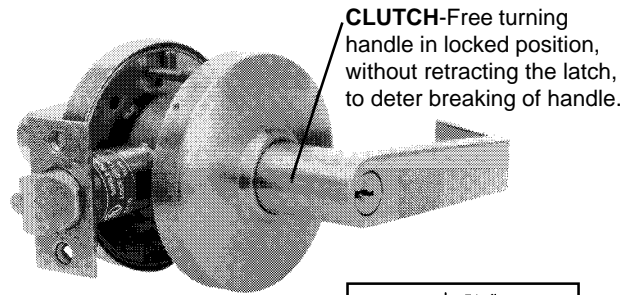

- SPECIFICATIONS**
- DOOR THICKNESS:** 1-3/8" to 1-3/4"
- BACKSET:** 2-3/4" square face-UL Listed
1-1/8" wide face
- STRIKE:** ASA, 1-1/4" x 4-7/8"
- BORE:** 2-1/8" x 1"
- THRU-BOLTS:** 5/16" Diam. 2-3/4" center to center
- ROSE:** 3-1/2"
- KEYWAY:** 6 pin solid brass "C" keyway, furnished keyed different. **For other keyways use Iico cylinder 15395 on page 286.**
I/C: Will accept 6 or 7 pin Best, Arrow or Falcon cores & Schlage full size cores.
- FINISHES:** **US3(605)** Polished Brass
10B(613) Oil Rubbed Bronze
26D(626) Satin Chrome

Interchangeable Core locks NOW AVAILABLE FOR small format or full size cores. Cores sold separately. See next page for cores.

Function	No.	*I/C No.	Operation
Entrance/Office	GE-CGN-00-	GE-IC***-00-	Turn/Push button locking. Pushing and turning button locks outside lever requiring use of key until button is manually unlocked. Push-button locking. Pushing button in inside lever locks outside lever. Turning inside lever or operating key in outside lever releases button automatically.
Classroom	GE-CGN-03-	GE-IC***-03-	Deadlocking latch bolt operated by lever from either side except when outside lever is locked from outside by key. When outside lever is locked, latch bolt is operated by turning inside lever.
Storeroom	GE-CGN-05-	GE-IC***-05-	Outside lever fixed. Entrance by key only. Inside lever always unlocked.
Privacy	GE-CGN-20-	—	Latch bolt operated by lever from either side. Outside lever is locked by push button inside and unlocked by emergency release outside. Turning inside lever or closing door releases push button.
Passage	GE-GN-30-	—	Latch bolt operated by lever from either side at all times.
Dummy	GE-GN-40-	—	Single dummy trim for one side of door. Pull only.

***Cores not included - order separately. SEE NEXT PAGE.**

*****Specify CGN for small format core; GYS for full size core (Schlage)**

To Order, Specify:

Function: **GE-CGN-00-** Entrance
 Finish: **26D** Satin Chrome
 Latch: **234** 2-3/4" Backset

©ZIPF LOCK COMPANY

CAL-ROYAL

10 locks per case

OMEGA GRB SERIES GRADE 1

CAL-ROYAL

Extra Heavy Duty Cylindrical Lockset

- ANSI A156.2 Series 4000, Grade 1.
- U.L. Listed For 3 Hour Doors.
- 1-year Mechanical Warranty.
- Solid Brass 6-pin Cylinder. "C" Keyway.

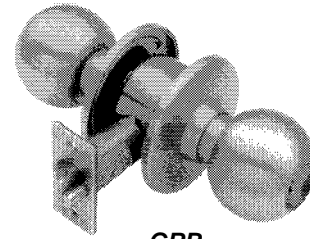

GRB
US-32D

SPECIFICATIONS

DOOR THICKNESS: 1-3/8" to 2"
BACKSET: 2-3/4" square face-UL Listed
 1-1/8" wide face
STRIKE: ASA, 1-1/4" x 4-7/8"
BORE: 2-1/8" x 1"
ROSE: 3"
KEYWAY: 6 pin solid brass "C" keyway, furnished
 keyed different. **For other keyways use**
Ilco cylinder 15395 on page 286.
FINISHES: 32D(630) Satin Stainless Steel

To Order, Specify:

Function: **GRB-00-** Entrance
 Finish: **32D** Satin Stainless Steel
 Latch: **234** 2-3/4" Backset

<u>Function</u>	<u>No.</u>	<u>Operation</u>	<u>ANSI</u>
Entrance	GRB-00-	Push button locking. Pushing button in inside knob locks outside knob until unlocked with key or turning inside knob. Closing door does not release button.	F82
Classroom	GRB-03-	Deadlocking latchbolt operated by knob from either side except when outside knob is locked from outside by key. When outside knob is locked, latchbolt is operated by key in outside knob or by rotating inside knob.	F84
Storeroom	GRB-05-	Deadlocking latchbolt operated by key in outside knob or by rotating inside knob. Outside knob is always fixed.	F86
Privacy	GRB-20-	Latchbolt operated by knob either side. Outside knob is locked by push button inside and unlocked by emergency release outside, rotating inside knob or closing door.	F76
Passage	GRB-30-	Latchbolt operated by knob from either side at all times.	F75

SMALL FORMAT CORES

Stock No. **Length**
AR-C6S-UC 6 pin
AR-C7S-UC 7 pin

Keyways: 1D, AB, BB, DB, EB,
 FB, GB, HB, JB, KB, MB.

Finishes: 4-Satin Brass
 26D-Satin Chrome

To Order, Specify:
 Stock No. Keyway and Finish (AR-C6S-UC AB 26D)



FULL SIZE CORES

INTERCHANGEABLE CORES

Stock No. **Finish** v1
23-030-C 606, 626
23-030-C123 606, 626
23-030-C145 606, 626
23-030-E 606, 626

FINISHES: 606 Satin Brass
 626 Satin Chrome
TO ORDER: Specify Stock No. and Finish.

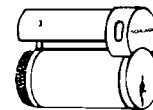

CAL-ROYAL

10 locks per case

PIONEER SERIES GRADE 2

CAL-ROYAL

Standard Duty Cylindrical Leverset

- ANSI A156.2 Series 4000, Grade 2.
- U.L. Listed For 3 Hour Doors.
- 1-year Mechanical Warranty***.
- Non-Handed.
- Levers BOTH Sides.
- Individual Spring on Each Side To Prevent Lever sag, Maintain Reliability, Reduce Maintenance.
- Coil Compression Springs Provide Great Strength and Durability.
- Solid Brass 6-pin Cylinder. "C" Keyway.
- Also Available in Interchangeable Core.

SPECIFICATIONS

- DOOR THICKNESS:** 1-3/8" to 1-3/4"
BACKSET: 2-3/4" square face-UL Listed
 1-1/8" wide face
STRIKE: ASA, 1-1/4" x 4-7/8"
BORE: 2-1/8" x 1"
THRU-BOLTS: 5/16" Diam. 2-3/4" center to center
ROSE: 3-5/16"
KEYWAY: 6 pin solid brass "C" keyway, furnished keyed different. **For other keyways use Ico cylinder 15395 on page 286.**
I/C: Will accept 6 or 7 pin Best, Arrow or Falcon cores.
FINISHES: US-3 Polished Brass 5 Antique Brass
 10 Satin Bronze 10B Oil rubbed Bronze
 15 Satin Nickel 26D Satin Chrome

I/C stocked in 26D finish only.

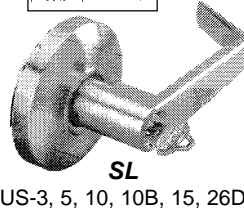
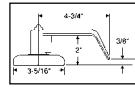

Meets ADA requirements. Specially designed for Barrier Free Applications.

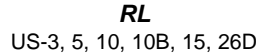
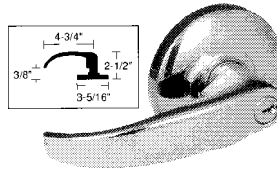
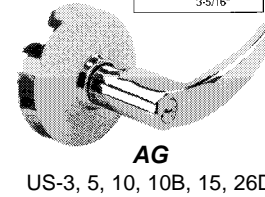
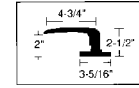

With Convertible Thrubolt. Removeable Thrubolts are provided and recommended for use on high frequency doors.

*Abbreviation Definition

- PIO-**** Standard lock
PIO-C** Standard lock with clutch function
PIO-IC** Interchangeable core lock (small format)
PIO-ICC** Interchangeable with clutch function
****Specify design: AG, RL or SL**

Cores not included with I/C locks - order separately. See page 118 for cores.

Function	*No.	*I/C No.	Operation
Entrance/Office	PIO-**-00- PIO-C**-00-	PIO-IC**-00- PIO-ICC**-00-	Turn/Push button locking. Pushing and turning button locks outside lever requiring use of key until button is manually unlocked. Pushing button in inside lever locks outside lever. Turning inside lever or operating key in outside lever releases button automatically.
Classroom	PIO-**-03- PIO-C**-03-	PIO-IC**-03- PIO-ICC**-03-	Deadlocking latch bolt operated by lever from either side except when outside lever is locked from outside by key. When outside lever is locked, latch bolt is operated by turning inside lever.
Storeroom	PIO-**-05- PIO-C**-05-	PIO-IC**-05- PIO-ICC**-05-	Outside lever fixed. Entrance by key only. Inside lever always unlocked.
Privacy	PIO-**-20- PIO-C**-20-	—	Latch bolt operated by lever from either side. Outside lever is locked by push button inside and unlocked by emergency release outside. Turning inside lever or closing door releases push button.
Passage	PIO-**-30-	—	Latch bolt operated by lever from either side at all times.
Dummy	PIO-**-40-	—	Single dummy trim for one side of door. Pull only.
Exit	PIO-**-50-	—	Blank plate outside. Inside lever always unlocked.

**Specify design: AG, RL or SL

To Order, Specify:

- Function: **PIO-SL-00-** Entrance
 Finish: **26D** Satin Chrome
 Latch: **234** 2-3/4" Backset
 •Interchangeable Core only available in 26D finish.

***There is no mechanical warranty if installed on educational facilities and/or extensive high traffic doors.

CAL-ROYAL

20 locks per case

BARRINGTON SERIES GRADE 2

CAL-ROYAL

Quality Designed and
Engineered For Residential
and Commercial Buildings.

Standard Duty Cylindrical Knobset

- ANSI A156.2 Series 4000, Grade 2
- U.L. Listed for 3 Hour Doors.
- 1-year Mechanical Warranty.
- Internal Mechanism Heavy Gauge Cold Rolled Steel, All Parts Are Zinc Plated and Dichromated to Assure Protection From Rust Or Corrosion.
- Long Spindle Hub Eliminates Knob Wobble.
- **Solid Brass 6-pin Cylinder. "C" Keyway.**

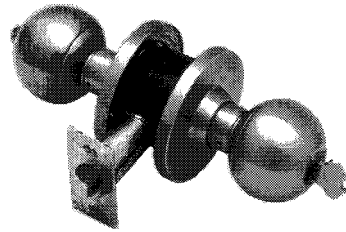

SPECIFICATIONS

DOOR THICKNESS: 1-3/8" to 1-3/4"
BACKSET: 2-3/4" square face-UL Listed
 1-1/8" wide face

STRIKE: ASA, 1-1/4" x 4-7/8"
BORE: 2-1/8" x 1"
ROSE: 2-15/16"
KEYWAY: 6 pin solid brass "C" keyway
 BA-00 furnished KA-4, balance BA
 furnished keyed different. PLY KA-4.
**For other keyways use Ilco cylinder
 15395 on page 286.**

FINISHES: **US-3(605)** Bright Brass
10B(613) Oil rubbed Bronze
32D(630) Stainless Steel

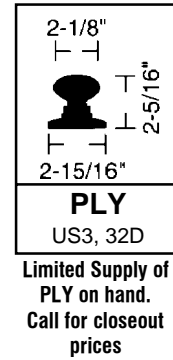
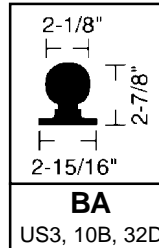

Function	No.	Operation	ANSI
Entrance	-00-	Pushing turn-button in inside knob locks outside knob. Turning inside knob or operating key in outside knob releases button automatically. Closing door does not release button. Button may be fixed in locked position by turning to horizontal position. Inside knob always free. Latchbolt automatically deadlocks when door is closed.	F82-2
Classroom	-03-	Deadlocking latchbolt operated by knob from either side except when outside knob is locked from outside by key. When outside knob is locked, latchbolt is operated by key in outside knob or by rotating inside knob.	F84-2
Storeroom	-05-	Deadlocking latchbolt operated by key in outside knob or by rotating inside knob. Outside knob is always fixed.	F86-2
Privacy	-20-	Latch bolt operated by knob either side. Outside knob is locked by push button inside and unlocked by emergency release outside, rotating inside knob or closing door.	F76-2
Passage	-30-	Latch bolt operated by knob from either side at all times.	F75-2

To Order, Specify:

Design: **BA** BA
 Function: **-00-** Entrance
 Finish: **32D** Satin Stainless Steel
 Latch: **234** 2-3/4" Backset

Limited availability of 2-3/8" U.L. backset

CAL-ROYAL

ASHLEY SERIES

Residential Duty

- ANSI A156.2, Grade 3.
- Reversible for Right or Left Hand Doors.
- 10-year Mechanical Warranty.
- 5-year Finish Warranty.
- Brass Trim and Brass Plated Levers.
- Brass Trim and Knob.
- **Kwikset Keyway. Re-keyable for Master and Construction Keying.**

CAL-ROYAL

Levers: 24 locks per case
Knobs: 36 locks per case



"LE" Available
SIGNATURE(SIG)
US-3, 5, 26D



Discontinued-see next page. Call for closeout prices

"LE" Available
ELITE(ELI)
US-3,5, 26D



"LE" Available
PREMIER(PRE)
US-3, 5, 10B, 15, 15A, 26D



Discontinued-see next page. Call for closeout prices

"LE" Available
MILLENNIUM(MIL)
US-3, 15A, 26D



Discontinued-see next page. Call for closeout prices

HARTFORD(HAR)
US-3

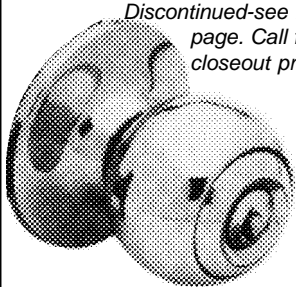

Discontinued-see next page. Call for closeout prices

BRAVO(BRV)
US-3, 5, 15A, 26, 26D

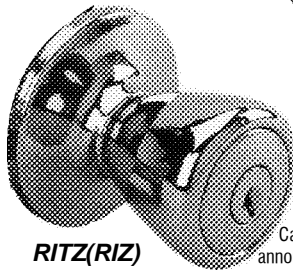

RITZ(RIZ)
US-3, 5, 26D

Cal Royal has announced a rolling design change on Ritz non keyed functions.

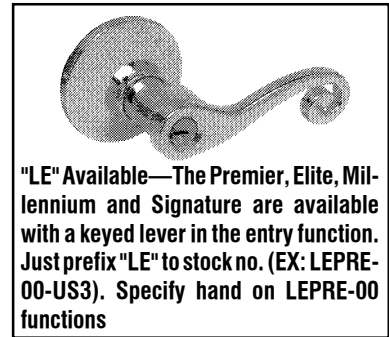

"LE" Available—The Premier, Elite, Millennium and Signature are available with a keyed lever in the entry function. Just prefix "LE" to stock no. (EX: LEPRE-00-US3). Specify hand on LEPRE-00 functions

SPECIFICATIONS

- DOOR THICKNESS:** 1-3/8" to 1-3/4"
BACKSET: Adjustable 2-3/8" or 2-3/4" with round corner face.
STRIKE: Round corner full lip
BORE: 2-1/8" x 1"
ROSE: 2-5/8"
KEYWAY: Kwikset 1063P (KW1). Locks furnished KA-3 except "LE" and 05 function KD.
FINISHES:
- | | |
|---------------------|-------------------|
| US3(605) | Bright Brass |
| US5(609) | Antique Brass |
| US-10B (613) | Oil Rubbed Bronze |
| US-15 (619) | Satin Nickel |
| US15A(620) | Antique Nickel |
| US26(625) | Bright Chrome |
| US26D(626) | Satin Chrome |

Function

Function	No.	Operation
Entry	00-	Key from outside or turn button inside locks or unlocks both outside knob and inside knob/lever.
Storeroom (Vestibule)	05-	Plain inside knob, always free. Outside knob always locked.
Privacy (Bed & Bath)	20-	Turning button inside locks both knobs/levers. Emergency entry from outside.
Passage (Hall & Closet)	30-	Plain knobs/levers on both sides.
Dummy	40-	Single dummy trim for one side of door. Pull only.

•Keyed lever locks have Bravo (ball) knob on exterior. Vestibule (05) available in BRV and RIZ design only.

To Order, Specify:

Design: **PRE** Premier Lever
Function: **-00-** Entrance
Finish: **US3** Bright Brass
Latch: **RCAL** Adjustable R.C.

©ZIPF LOCK COMPANY

CAL-ROYAL

CHELSIE SERIES

Residential Duty

- ANSI A156.2, Grade 3.
- 25-year Mechanical Warranty.
- 5-year Finish Warranty.
- Brass Trim and Brass Plated Levers.
- Brass Trim and Knob.
- **Kwikset Keyway. Re-keyable for Master and Construction Keying.**

CAL-ROYAL

Dummy: 36 locks per case
Levers: 24 locks per case
Knobs: 36 locks per case

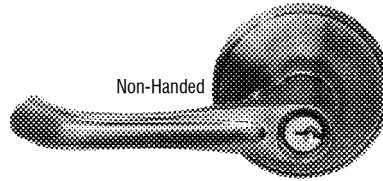

AUSTIN(CH-AUS)
US-3, 5, 10B, 15, 15A

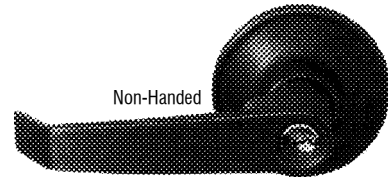

BRISTOL(CH-BRI)
US-3, 5, 10B, 15, 26D

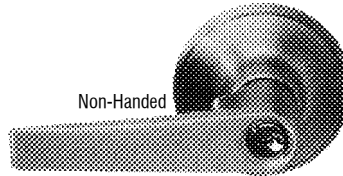

LENOX(CH-LEN)
US-5, 10B, 15, 26, 26D

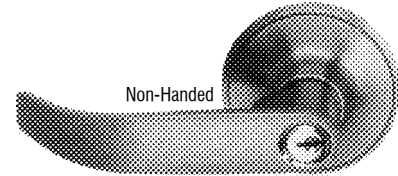

SOPHIA(CH-SOP)
US-3, 10B, 15

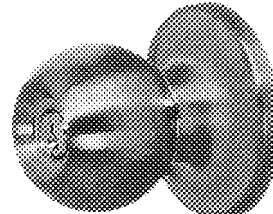

RENO(CH-REN)
US-3, 5, 10B, 15, 15A,
26, 32D

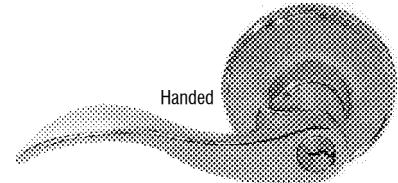

MAYFAIR(CH-MAY)
US-3, 5, 10B, 15, 15A, 26, 26D

SPECIFICATIONS

DOOR THICKNESS: 1-3/8" to 1-3/4"

BACKSET: Adjustable 2-3/8" or 2-3/4" with round corner face.

STRIKE: Round corner full lip

BORE: 2-1/8" x 1"

ROSE: 2-5/8"

KEYWAY: Kwikset 1063P (KW1).
Locks furnished KA-3.

FINISHES:
US3(605) Bright Brass
US10B(613) Oil Rubbed Bronze
US15(619) Satin Nickel
US-26D(626) Satin Chrome
US-32D Stainless Steel

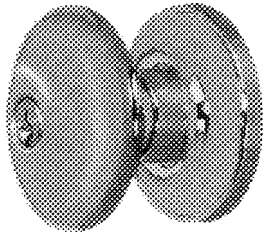

ASPEN(CH-ASP)
US-3, 10B, 15, 15A

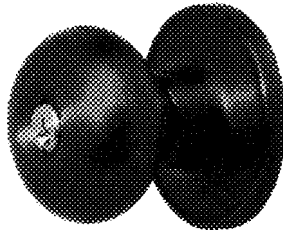

BERMUDA(CH-BER)
US-3, 10B, 15, 15A, 26,
26D

Function

Entry

Privacy (Bed & Bath)

Passage (Hall & Closet)

Dummy

No.

00-

20-

30-

40-

Operation

Key from outside or turn button inside locks or unlocks both outside knob and inside knob/lever.

Turning button inside locks both knobs/levers. Emergency entry from outside.

Plain knobs/levers on both sides.

Single dummy trim for one side of door. Pull only.

To Order, Specify:

Design: **CH-MAY** *Mayfair Lever*
 Function: **-00-** *Entrance*
 Finish: **US3** *Bright Brass*
 *Handing: **RH** *Right Hand*
 Latch: **RCAL** *Adjustable R.C.*
 *only required on Mayfair design.

Please note some finishes are special order

All entrance levers have a lever on the exterior and the interior.

CORBIN/RUSSWIN

HEAVY DUTY KNOB CK4200 SERIES

FEATURES:

- ANSI A156.2 Series 4000, Grade 1
- U.L. Listed
- Reversible

SPECIFICATIONS

DOOR THICKNESS:	1-3/4" to 2"
BACKSET:	2-3/4" square face
STRIKES:	ASA
BORE:	2-1/8"
ROSE:	2-7/8"
KEYWAYS:	D1, L4 or 981
FINISHES:	612 Satin Bronze 613 Dark Oxidized Satin Bronze, Oil Rubbed 626 Satin Chromium Plated

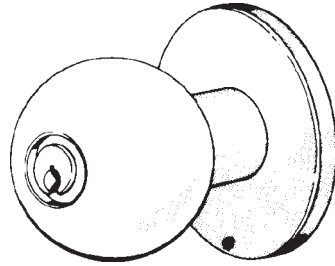

**GLOBAL
(GRC)**
613, 626

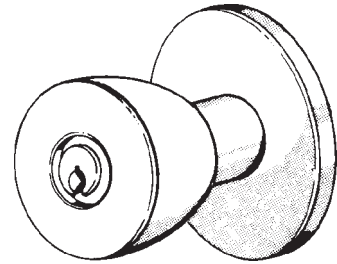

**BELMONT
(BRC)**
612, 626

Call for GREAT closeout prices.

<u>Function</u>		<u>Operation</u>
PASSAGE	\$CK4210	Latchbolt by knob either side. Both knobs always free. (ANSI F75)
PRIVACY	\$CK4220	Latchbolt by knob either side. Outside knob locked by push button. Outside knob unlocked by emergency release tool outside, by rotating inside knob or by closing door. Inside knob always free. (ANSI F76)
ENTRANCE	\$CK4251	Deadlocking latchbolt by knob either side, except when turn button locks outside knob. Key outside retracts latchbolt. Outside knob unlocked by turn button. Inside knob always free. (ANSI F81)
CLASSROOM	\$CK4255	Deadlocking latchbolt by knob either side, except when key outside locks outside knob. When outside knob is locked, latchbolt operated by key outside or by rotating inside knob. Inside knob always free. (ANSI F84)
STOREROOM	\$CK4257	Deadlocking latchbolt by key in outside knob or by rotating inside knob. Outside knob always rigid. Inside knob always free. (ANSI F86)

HOW TO ORDER: Specify,

Function:	RE-CK4251	Entrance
Design:	GRC	Global Design
Finish:	626	Satin Chrome
Keyway:	D1	D1 keyway

TUBULAR DEADLOCKS DL2000 SERIES

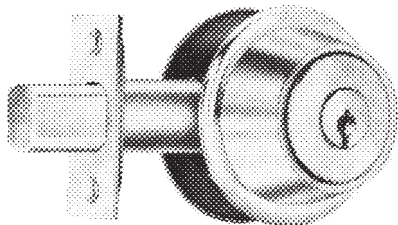

\$DL2013	Single Cylinder
\$DL2012	Double Cylinder

Call for GREAT closeout prices.

DOOR THICKNESS:	1-3/4" to 2"
BACKSET:	Adjustable for 2-3/8" or 2-3/4"
BORE:	2-1/8"
BOLT THROW:	1"
KEYWAYS:	D1, L4
FINISH:	605 Bright Brass 626 Satin Chromium Plated

©ZIPF LOCK COMPANY

CORBIN/RUSSWIN

STANDARD DUTY KNOB CK4400 SERIES

FEATURES:

- ANSI A156.2 Series 4000, Grade 2;
- U.L. Listed
- Reversible

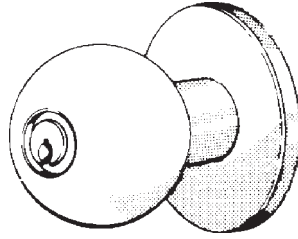

**GLOBAL
(GWC)**
613, 630

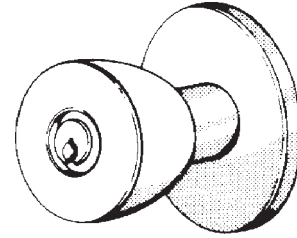

**BELMONT
(BWC)**
605, 612, 630

SPECIFICATIONS

DOOR THICKNESS: 1-1/4" to 1-3/4"

BACKSET: 2-3/4" square face

STRIKES: Global—ASA
Belmont—"T" type

BORE: 2-1/8" x 1"

ROSE: 3"

KEYWAYS: D1, L1 or 981

FINISHES: **605** Bright Brass

612 Satin Bronze

613 Dark Oxidized Satin Bronze,
oil rubbed

630 Satin Stainless Steel

*Call for GREAT
closeout prices.*

HOW TO ORDER: Specify,

Function:	RE-CK4451	Entrance
Design:	GWC	Global Design
Finish:	630	Satin Stainless Steel
Keyway:	D1	D1 keyway

Function

PASSAGE **\$CK4410**

Operation

Deadlocking latchbolt by knob either side. Both knobs always free. **(ANSI F75)**

PRIVACY **\$CK4430**

Deadlocking latchbolt by knob either side. Outside knob locked by push button. Outside knob unlocked by turning slotted button outside, by rotating inside knob, or by closing door. **(ANSI F76)**

ENTRANCE **\$CK4451**

Deadlocking latchbolt by either knob, except when turn button locks outside knob. Pushing turn button in locks outside knob, requiring use of key outside to unlock. Turning inside knob unlocks outside knob. Pushing in and turning button locks outside knob, requiring key at all times. Turning inside knob does not unlock outside knob until button is manually turned to unlocked position. Inside knob always free. **(ANSI F81)**

**We still stock:
CK4451 GWC 630 D1**

CLASSROOM **\$CK4455**

Deadlocking latchbolt by knob either side, except when key outside locks outside knob. When outside knob is locked, latchbolt is operated by key outside or by rotating inside knob. Inside knob always free. **(ANSI F84)**

STOREROOM **\$CK4457**

Deadlocking latchbolt by key in outside knob, or by rotating inside knob. Outside knob always rigid. Inside knob always free. **(ANSI F86)**

CYLINDRICAL DEADLOCKS DL3000 SERIES

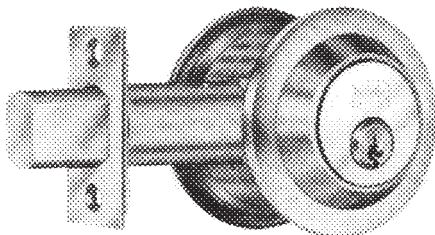

\$DL3011 Single Cylinder (Key outside/blank plate inside)

\$DL3012 Double Cylinder

DOOR THICKNESS: 1-3/4"

BACKSET: 2-3/4"

BORE: 2-1/8"

BOLT THROW: 1"

CYLINDER: Mortise

KEYWAYS: D1, L4

FINISH: **613** Dark Oxidized Satin Bronze, Oil Rubbed

626 Satin Chromium Plated

Call for GREAT closeout prices.

HOW TO ORDER: Specify,

Function:	RE-DL3013	Single Cylinder
Finish:	626	Satin Chromium Plated
Keyway:	D1	D1 keyway

©ZIPF LOCK COMPANY

NOTE: Many Corbin-Russwin locks are being phased out. We also have Schlage with Corbin-Russwin keyways.

**141 v1
(PL-5)**

CORBIN/RUSSWIN

HEAVY DUTY LEVER CL3500 SERIES (3600)

FEATURES:

- ANSI A156.2 Series 4000, Grade 1
- U.L. Listed
- Non-handed
- Solid cast levers
- Independent return springs to prevent lever sag
- Throughbolted cylindrical chassis

SPECIFICATIONS

DOOR THICKNESS: 1-3/8" to 2"
BACKSET: 2-3/4" square face
STRIKE: ASA
BORE: 2-1/8"
ROSE: 3-1/2"
KEYWAYS: D1, L4
FINISHES: **626** Satin Chromium Plated

Complies with codes requiring lever to return to within 1/2" of door face.



Throughbolts prevent chassis rotation; ensure proper alignment, smooth operation and long life.

Solid cast levers without plastic inserts.



**NEWPORT
(NZD)
626**

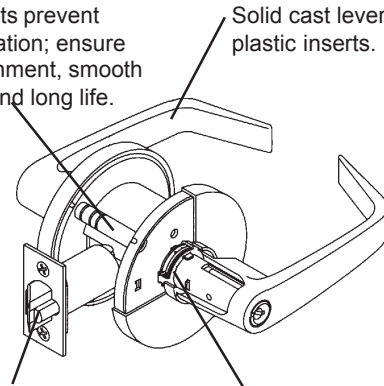

1/2" throw latchbolt accommodates 7/8" and 1" edge bore preps.

Non-handed spring cassette prevents lever sag.

Function
ENTRANCE

CL3551
(CL3651)

Operation

Deadlocking latchbolt by lever either side, except when turn button locks outside lever. Pushing turn button in locks outside lever, requiring use of key outside to unlock. Turning inside lever unlocks outside lever. Pushing in and turning button locks outside lever, requiring key at all times. Turning inside lever does not unlock outside lever until button is manually turned to unlocked position. Inside lever always free. (ANSIF81/82)

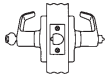

HOW TO ORDER: Specify,

Function:	RE-CL3551	Entrance
Design:	NZD	Newport Design
Finish:	626	Satin Chromium Plated
Keyway:	D1	D1 keyway

LATCHES

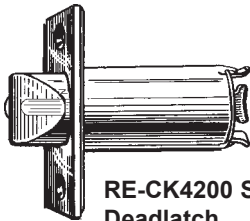

**RE-CK4200 Series
Deadlatch**

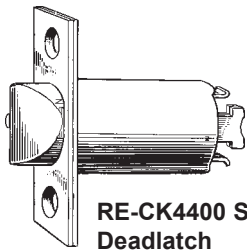

**RE-CK4400 Series
Deadlatch**

<i>RUSSWIN</i>	2-3/8" Square Face	2-3/4" Square Face
CK4200 Series Deadlatch		ZL-111 (486F89)
CK4430 Latch	ZL-422 (574F30)	ZL-423 (574F56)
CK4410, 51, 55, 57 Deadlatch	ZL-424 (574F29)	ZL-425 (574F55)

DEXTER

J SERIES KNOB AND LEVER LOCKS

For Residential Use

- ANSI A156.2, 1996, Series 4000, Grade 3.
- Residential 25-year Mechanical Warranty.
- Residential 5-year Finish Warranty.
- Rekeyable to Schlage Locks.
- Easy To Install.

DEXTER
by SCHLAGE



24 Locks per case
Dummy-50 per case

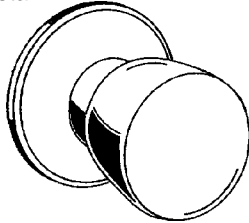

BYRON (BYR)
605, 609, 630

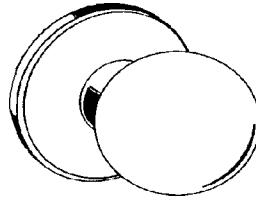

CORONA (CNA)
605, 609, 619, 620, 625, 630

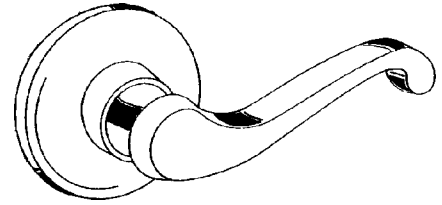

LA SALLE (LAS)
605, 609, 619, 620, 625, 630, 716
(Specify Hand - LH or RH)

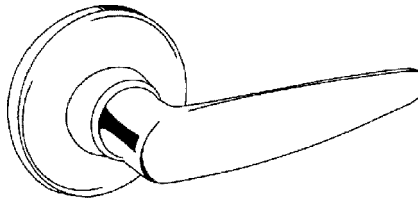

DOVER (DOV)
605, 609, 630

LEVERS HAVE Keyed
outside lever on J54.

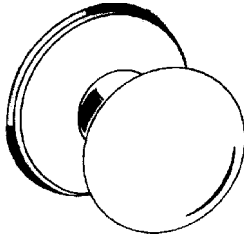

STRATUS (STR)
605, 619, 716

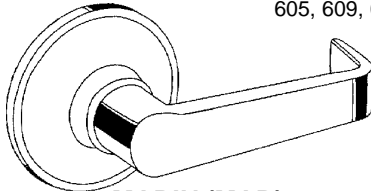

MARIN (MAR)
605, 609, 619, 620, 625, 630

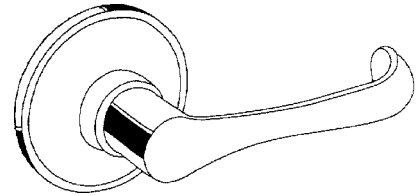

TORINO (TOR)
605, 609, 619, 620, 625, 630, 716

Function	No.	Operation	ANSI
PASSAGE	J10	Both knobs/levers are always unlocked.	F75
BATH/BEDROOM PRIVACY	J40	Turn-button locking. Can be opened from outside by turning outside turn mechanism. Turning inside turn button releases inside knob/lever.	F77
ENTRANCE	J54	Unlocked by key from outside when outer knob is locked by turn-button in inside knob. Inside knob/lever is locked and unlocked by turn-button.	F81
SINGLE DUMMY	J170	Single dummy trim for one side of door. Used for door pull or as matching inactive trim.	

SPECIFICATIONS

DOOR THICKNESS:	1-3/8" to 1-3/4"
BACKSET:	AL-Adjustable for 2-3/8" or 2-3/4" with square and round corner face plates. DI-Adjustable Drive-in latch. (Special)
STRIKE:	1/4" Radius full lip.
BORE:	2-1/8" x 1"
KEY BLANK:	J750-000
KEYWAY:	Schlage C Keyway, 5-pin
FINISHES:	605 (US-3) Bright Brass 609 (US-5) Antique Brass 619 (US-15) Satin Nickel 620 (US-15A) Antique Pewter 625 (US-26) Bright Chrome 630 (US-32D) Satin Stainless Steel 716 New Aged Bronze

To Order, Specify:

Function: **J54** Entrance
Design: **LAS** LaSalle
Finish: **605** Bright Brass
*Handing: **RH** Right Hand
Latch: **AL** Adjustable Latch
* Handing required on LaSalle.

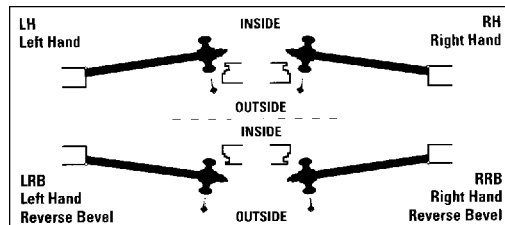

©ZIPF LOCK COMPANY

KWIKSET

KNOB LOCKS

- ANSI A156.2 Grade 2.
- Compatible With Kwikset's 5-Pin Keying Systems.
- 6-Pin, Front Removable Cylinder (cylinder removal tool required)
- Lifetime Mechanical Warranty.
- 10-year Finish Warranty.
- Lifetime Finish on **LO3** finish.

Kwikset
UltraMax
Signatures

12 locks per case
Dummy-20 locks per case

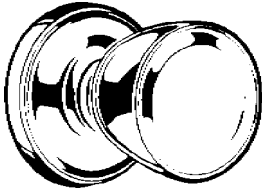

ABBEY (A)
US-3, 5, 26D
(720A & 740A also LO3)

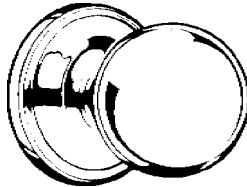

CIRCA (CA)
US-3, 5, 10B, 11P, 15, 15A, 26, 26D
(730CA also 3x26, 5x26)

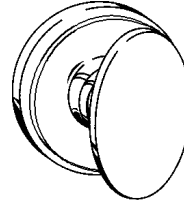

LAUREL (L)
US-3, 5, 10B, 11P, 15, 15A, 26
(740L also LO3)

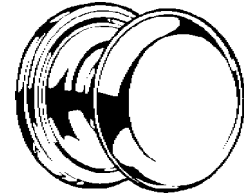

HANCOCK (H)
US-3, 5, 10B, 11P, 15, 15A, 26, 26D
(740H also LO3)
(730H also 3x26)

To Order, Specify:

Function: **740** *Entry*
Design: **CA** *Circa*
Finish: **US-3** *Polished Brass*
Latch: **6WAL** *6-way adjustable*

See page 152 for details on 6WAL latch.

SPECIFICATIONS

DOOR THICKNESS: 1-3/8" to 1-3/4".
***BACKSET:** 6WAL-Adjustable latch for 2-3/8", 2-3/4" with Square Face/Round Face/Drive-in.
***STRIKE:** RCS, SCS
*Selection may be limited.
BORE: 2-1/8" x 1"
ROSE: 2-5/8"
CYLINDER: 6-pin
KEY BLANK: KW-81208 (KW-88260)
FINISHES:
US-LO3 (605E) Polished Brass-Lifetime
US-3 (605) Polished Brass
US-5 (609) Antique Brass
***US-10B** (613) Oil Rubbed Bronze
US-11P Venetian Bronze
US-15 (619) Satin Nickel
US-15A (620) Antique Nickel
US-26 (625) Polished Chrome
US-26D (626) Satin Chrome

***NOTE:** The factory is discontinuing the 10B finish.

KwikInstall™

Featuring Kwik-Install:

- 1) Install latch and strike.
- 2) Install the patent pending mounting plate and tighten the pre-set screws.
- 3) Mount the interior knob assembly and rotate to complete the installation

Function	No.	Operation
PASSAGE/HALL/CLOSET	720	Both knobs always free.
PRIVACY/BED/BATH	730	Both knobs locked or unlocked by turnbutton inside. Outside knob unlocked by emergency key. (KW-81087)
PRIVACY/BATHROOM	730	Same function as 730 above. Inside knob polished chrome.
ENTRY	740	Both knobs locked or unlocked by key outside and turnbutton inside.
ENTRY	741	Outside knob locked or unlocked by key outside or turnbutton inside. Inside always free.
CLASSROOM	744	Outside locked or unlocked by key outside. Inside always free.
STOREROOM/VESTIBULE	750	Outside unlocked only while key is turned. Inside always free.
I/2 DUMMY	788	For doors where only a pull is required. Surface mounted.

©ZIPF LOCK COMPANY

KWIKSET

LEVER LOCKS

- ANSI A156.2 Grade 2.
- Compatible With Kwikset's 5-Pin Keying Systems.
- 6-Pin Cylinder.
- Lifetime Mechanical Warranty.
- 10-year Finish Warranty.
- Lifetime Finish on **LO3** Finish.

Kwikset
UltraMax
Signatures

12 locks per case
Dummy - 20 locks per case

NEW ROSE-At the time of this printing Kwikset was changing the BRL & CHL to a more decorative rose.

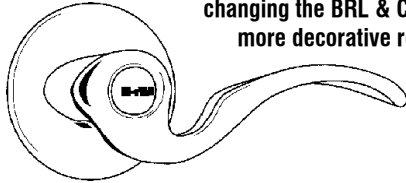

BROOKLANE (BRL)

US-3, 5, 10B, 11P, 15, 15A, 26, 26D
(740BRL also LO3)

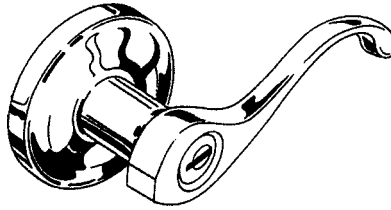

COMMONWEALTH (CHL)

US-3, 5, 10B, 11P, 15, 15A, 26, 26D
(740CHL also LO3)

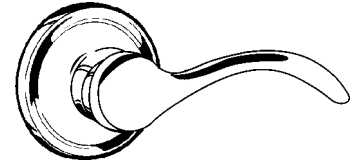

PEMBROKE (PML)

US-LO3, 3, 5, 10B, 15, 15A, 26, 26D

To Order, Specify:

Function : **740** *Entry*
Design: **CHL** *Commonwealth*
Finish: **US-3** *Polished Brass*
*Handing: **LH** *Left Hand*
Latch: **6WAL** *6-way Adjustable Latch*

* Handing required on 740, 788 functions
(SEE BELOW FOR HOW TO DETERMINE HANDING)

See page 152 for details on 6WAL latch.

Functions 720, 788 satisfy section 4.13.9 ADA requirement.

SPECIFICATIONS	
DOOR THICKNESS:	1-3/8" to 1-3/4"
*BACKSET:	6WAL-Adjustable latch for 2-3/8", 2-3/4" with Square Face/Round Face/Drive-in. RCS, SCS *Selection may be limited.
*STRIKE:	2-1/8" x 1" 2-5/8"
BORE:	6-pin
ROSE:	KW-81208 (KW-88260)
CYLINDER:	US-LO3 (605E) Polished Brass-Lifetime
KEY BLANK:	US-3 (605) Polished Brass
FINISHES:	US-5 (609) Antique Brass
	*US-10B (613) Oil Rubbed Bronze
	US-11P Venetian Bronze
	US-15 (619) Satin Nickel
	US-15A (620) Antique Nickel
	US-26 (625) Polished Chrome
	US-26D (626) Satin Chrome

*NOTE: The factory is discontinuing the 10B finish.

Function	No.	Operation
PASSAGE/HALL/CLOSET	720	Both levers always free.
PRIVACY/BED/BATH	730	Both levers locked or unlocked by turnbutton inside. Outside lever unlocked by emergency key. (KW-81087)
KEYED ENTRY	740	Outside locked or unlocked by key outside or turnbutton inside.
I/2 DUMMY	788	For doors where only a pull is required. Surface mounted.

HOW TO DETERMINE THE HANDING OF A DOOR:

- The hand of a door is always determined by facing the OUTSIDE of a door.
- If the hinge is on the left side of the door, the door is left handed (LH).
- If the hinge is on the right side of the door, the door is right handed (RH).
- To determine the hand of a dummy lever, face the side of the door it will be used on. If hinges are on left, order L.H., if hinges are on right, order R.H.

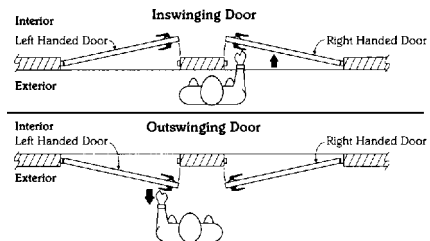

©ZIPF LOCK COMPANY

KWIKSET

RESIDENTIAL LIGHT COMMERCIAL LEVER

- A156.2, Grade 2
- UL Listed optional.
- Lever functions meet 4.13.9 ADA requirement.
- 5-Pin Cylinder
- ADA Turnpiece.
- 25-year Mechanical Warranty**
- 5-year Finish Warranty*

**For products used in "residential" applications.

Kwikset
Maximum
SECURITY

20 locks per case

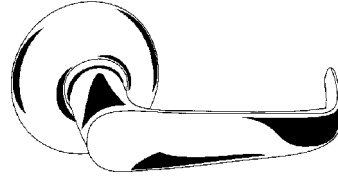

KINGSTON (KNL)
US-3, 5, 15A, 26, 26D

Function	No.	*U.L. No.	Operation
PASSAGE/HALL/CLOSET	200	420	Both levers always free.
PRIVACY/BED/BATH	300	430	Both levers locked or unlocked by ADA turnbutton inside. Outside lever unlocked by emergency key. (KW-81087)
KEYED ENTRY LEVER	405		Both levers locked or unlocked by key outside or ADA turnbutton inside.
KEYED ENTRY LEVER	406	413	Outside lever locked or unlocked by key outside or turnbutton inside. Inside always free.
STOREROOM/VESTIBULE 1/2 DUMMY	462 488	412	Outside lever unlocked only while key is turned. Inside always free. For doors where only a pull is required. Surface mounted.

*UL has 2-3/4" wide face latch.
and only in US-3, 26D.

To Order, Specify:

Function #: **405** *Keyed Entry*
 Design: **KNL** *Kingston*
 Finish: **US-3** *Polished Brass*
 *Latch: **6WAL** *6-way Adjustable*
 *See below for details on 6WAL latch.
 UL Listed locks only available with fixed backset.

SPECIFICATIONS

DOOR THICKNESS: 1-3/8" to 1-3/4"
BACKSET: 6WAL-Adjustable latch for 2-3/8", 2-3/4" with Square Face/Round Face/Drive-in. UL Locks are 2-3/4" with 1-1/8" wide face.
STRIKE: 2-1/4" full lip strike. UL Locks are 2-5/8" T-Strike.
BORE: 2-1/8" x 1"
ROSE: 2-5/8"
CYLINDER: 5-pin
KEY BLANK: KW-81063
FINISHES: **US-3** (605) Polished Brass
US-5 (609) Antique Brass
US-15A (620) Antique Nickel
US-26 (625) Polished Chrome
US-26D (626) Satin Chrome

6-WAY UNIVERSAL LATCH For Kwikset Knob & Lever Locks

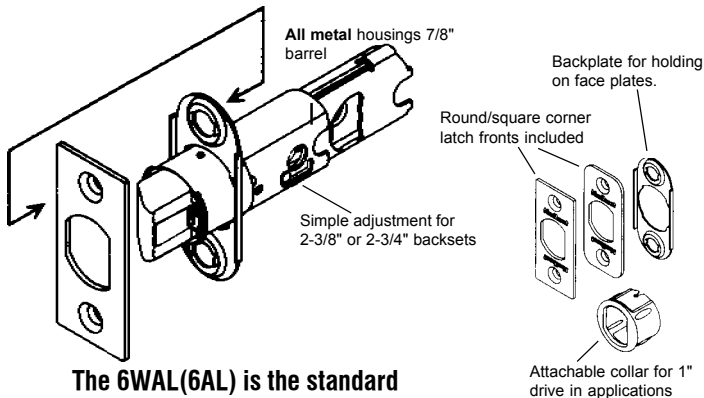

The 6WAL(6AL) is the standard latch for most knob and lever locks.

SPECIAL KEYING AVAILABLE:

- KEYING ALIKE(KA)
- MASTER KEYING(MK)
- GRAND MASTER KEYING(GMK)
- MAISON KEYING
- PROTECTO KEYING(PK)
- PROTECTO MASTER KEYING(PMK)

KWIKSET



20 locks per case
400 Function 12 locks per case

LEVER LOCKS

- ANSI A156.2 Grade 2
- Lifetime Mechanical Warranty.
- 5-year Finish Warranty.
- Lifetime Finish Warranty on LO3 Finish.

200, 488 functions satisfy Section 4.13.9 ADA requirements

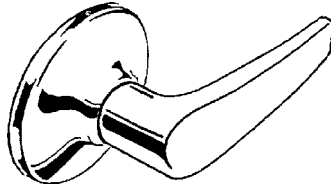

DELTA (DL)
US-3, 5, 15A, 26, 26D
(300DL also 3x26)

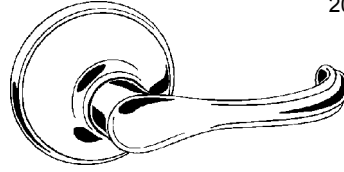

DORIAN (DNL)
US-3, 5, 11P, 15,
15A, 26, 26D



TUSTIN (TNL)
US-3, 5, 11P, 15, 15A, 26, 26D
(488 Specify Hand - LH or RH)

Keyed Levers are available in 405, 406, 462 functions. Limited finish availability.

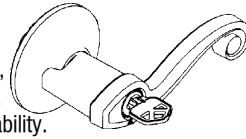

400 FUNCTION HAS COPA KNOB ON THE OUTSIDE EXCEPT FOR 15 FINISH WHICH HAS CAMERON KNOB

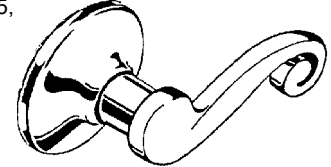

LIDO (LL)
US-3, 5, 15, 15A, 26, 26D
(300LL also 3x26)
(400LL also LO3)
(Specify Hand - LH or RH)



SAXTON (SNL)
US-3, 5, 15, 15A, 26, 26D
(400SNL also LO3)
(Specify Hand - LH or RH)

Limited Supply
Discontinued by Factory
Replaced by TNL above

To Order, Specify:

Function: **405** *Keyed Entry*
Design: **LL** *Lido Lever*
Finish: **US-3** *Polished Brass*
*Handing: **LH** *Left Hand*
Latch: **6WAL** *6-way adjustable*

* Handing required on Lido and Saxton. Tustin 488's.
(SEE BELOW FOR HOW TO DETERMINE HANDING)

See page 152 for details on 6WAL latch.

DOOR THICKNESS: 1-3/8" to 1-3/4"
BACKSET: 6WAL-Adjustable latch for 2-3/8", 2-3/4"

BORE: 2-1/8" x 1"
ROSE: 2-5/8"
CYLINDER: 5-pin
KEY BLANK: KW-81063
FINISHES:

SPECIFICATIONS

US-LO3 (605E) Polished Brass-Lifetime
US-3 (605) Polished Brass
US-5 (609) Antique Brass
US-11P Venetian Bronze
US-15 (619) Satin Nickel
US-15A (620) Antique Nickel
US-26 (625) Polished Chrome
US-26D (626) Satin Chrome

Function	No.	Operation
PASSAGE/HALL/CLOSET	200	Both levers always free.
PRIVACY/BED/BATH	300	Both levers locked or unlocked by turnbutton inside. Outside lever unlocked by emergency key. (KW-81087)
ENTRY	400	Both sides locked or unlocked by key outside or turnbutton inside.
KEYED ENTRY LEVER	405	Both levers locked or unlocked by key outside or turnbutton inside.
KEYED ENTRY LEVER	406	Outside lever locked or unlocked by key outside or turnbutton inside. Inside always free.
STOREROOM/VESTIBULE	462	Outside lever unlocked only while key is turned. Inside always free. (<i>DL, LL, SNL ONLY</i>)
1/2 DUMMY	488	For doors where only a pull is required. Surface mounted.

HOW TO DETERMINE THE HANDING OF A DOOR:

- The hand of a door is always determined by facing the OUTSIDE of a door.
- If the hinge is on the left side of the door, the door is left handed (LH).
- If the hinge is on the right side of the door, the door is right handed (RH).
- To determine the hand of a dummy lever, face the side of the door it will be used on. If hinges are on left, order L.H., if hinges are on right, order R.H.

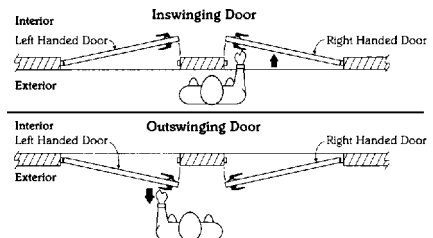

©ZIPF LOCK COMPANY

KWIKSET

Kwikset Maximum SECURITY

KNOB LOCKS

- ANSI A156.2 Grade 2
- Lifetime Mechanical Warranty on Belair, Copa and Cameron.
- 5-year Finish Warranty.
- Lifetime Finish Warranty on LO3 Finish.

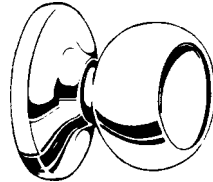

COPA (C)
US-3, 5, 15A, 26, 26D
(300C also 5x26)
(400C also LO3)

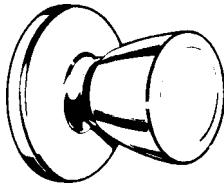

BELAIR (B)
US-3, 5
(300B also 3x26)
(400B also LO3, 26D)

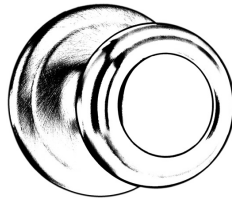

CAMERON (CN)
US-3, 5, 11P, 15,
15A, 26
(300E also 3x26)

To Order, Specify:

Function: **400** *Keyed Entry*
Design: **B** *Belair*
Finish: **US-3** *Polished Brass*
Latch: **6WAL** *6-way Adjustable*

See page 152 for details on 6WAL latch.

KwikInstall

Feature Kwik Install:

- 1) Install latch and strike.
- 2) Align interior knob with pre-set screws and half round. Then turn rose counter-clockwise.
- 3) Turn the rose clockwise to engage screws.

Function	No.	Operation
PASSAGE/HALL/CLOSET	200	Both knobs always free.
PRIVACY/BED/BATH	300	Both knobs locked or unlocked by turnbutton inside. Outside knob unlocked by emergency key. (KW-81087)
PRIVACY/BATHROOM ENTRY	300	Same function as 300 above. Inside knob polished chrome.
ENTRY	400	Both knobs locked or unlocked by key outside or turnbutton inside.
ENTRY	401	Outside knob locked or unlocked by key outside or turnbutton inside. Inside always free. (Polo and Tylo designs in US-3 only)
STOREROOM/VESTIBULE	450	Outside unlocked only while key is turned. Inside always free. (Belair US-3 only)
1/2 DUMMY	488	For use on door where only a pull is required. Surface mounted.

Kwikset Security

30 locks per case
Dummy - 20 locks per case

KNOB LOCKS

- ANSI A156.2 Grade 3
- Limited Lifetime Mechanical Warranty on Polo, Valiant and Tylo.
- 5-year Finish Warranty.

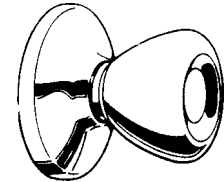

TYLO (T)
US-3, 5, 26, 26D
(300T also 3x26, 5x26)

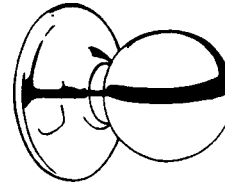

POLO (P)
US-3, 5, 11P, 15, 15A, 26,
26D
(300P also 3x26, 5x26)

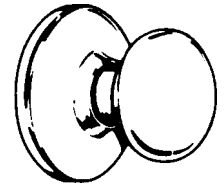

VALIANT (V)
US-3, 15
(300V also 3x26)

SPECIFICATIONS

DOOR THICKNESS: 1-3/8" to 1-3/4"
***BACKSET:** 6WAL-Adjustable latch for 2-3/8", 2-3/4" with Square Face/Round Face/Drive-in.
***STRIKE:** SCS, RCS
*Selection may be limited.
BORE: 2-1/8" x 1"
ROSE: 2-5/8"
CYLINDER: 5-pin
KEY BLANK: KW-81063
FINISHES:
US-LO3 (605E) Polished Brass-Lifetime
US-3 (605) Polished Brass
US-5 (609) Antique Brass
US-11P Venetian Bronze
US-15 (619) Satin Nickel
US-15A (620) Antique Nickel
US-26 (625) Polished Chrome
US-26D (626) Satin Chrome

SCHLAGE

20 locks per case

A SERIES



For Heavy Duty Residential and Medium Duty Commercial

- ANSI A156.2, 1996, Series 4000, Grade 2.
- UL Listed for 3-hour Fire Door.
- 3-year Mechanical Warranty.

COMMERCIAL APPLICATIONS
CONTRACTOR

See page 180 for Orbit CSV.

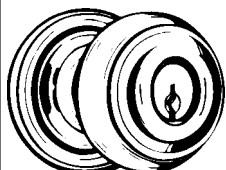

GEORGIAN (GEO)
605, 609
(NS: 606, 610, 625, 626)

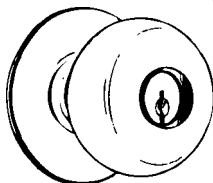

PLYMOUTH (PLY)
605, 612, 613, 626
(NS: 606, 609, 610, 611, 616, 625, 629, 630)

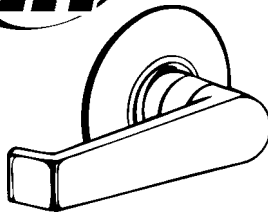

LEVON (LEV)
605, 613, 626
Keyed Locks have ORB knob outside.
(NS: 612)

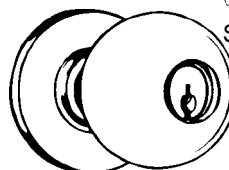

ORBIT (ORB)
605, 612, 613, 625, 626
Also stock JD in 626
(NS: 606, 609, 610, 611, 616)

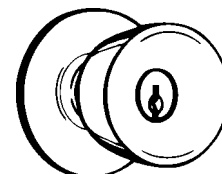

TULIP (TUL)
605, 626
(NS: 606, 609, 610, 625)

(NS) Non-stock finish available as factory special order. Some finishes may have factory special handling charge.

606-Satin Brass; 610-Bright Brass, Blackened, Bright Relieved; 611-Bright Bronze; 616-Antique Bronze, Satin Bronze, Blackened, Satin Relieved; 629-Bright Stainless Steel; 630-Satin Stainless Steel.

To Order, Specify:

Function: **A53PD** Entrance
Design: **PLY** Plymouth
Finish: **605** Bright Brass
*Latch: **234** 2-3/4" Backset

*Please specify latch. Selection may be limited.

Unless otherwise specified, 2-3/8" square face latch is standard. Specify **DI** for drive-in latch.

Specify if 1" wide latch is required for 2-3/4" backset.

Not all functions are available in all designs/finishes

Cylinder Options (Limited Selection-Please Call)

Just replace "PD" with...

LD- Less 6-Pin Cylinder.

JD- Less Full Size Interchangeable

Core. Pictured at right. (ORB 626)



23-030-C

23-030-C123

23-030-C145

23-030-E

SPECIFICATIONS

DOOR THICKNESS: 1-3/8" to 1-7/8"
BACKSET: 2-3/8", 2-3/4"
BORE: 2-1/8" x 7/8" (1" with latch collar)
ROSE: 2-9/16"
KEY BLANKS: 35-100- 5 pin
35-101- 6 pin

KEYWAYS: **PD-C** Standard, 6-pin, keyed to 5 pin
E, F Optional in most cases. **EVEREST-**
C123 or C145 also available.
LD- Less Cylinder-limited selection.
JD- Less Full Size Interchangeable Core-
limited selection (ORB 626).

FINISHES: **605**(US-3) Bright Brass, clear coated
609(US-5) Antique Brass, clear coated
612(US-10) Satin Bronze, clear coated
613(US-10B) Oil Rubbed Bronze
625(US-26) Bright Chrome
626(US-26D) Satin Chrome

Function	No.	Operation	ANSI
PASSAGE	A10S	Both knobs/levers always unlocked.	F75
EXIT	A25D	Blank plate outside. Inside knob always unlocked. FOR 1-3/4" THICK DOOR ONLY.	
BATH/BEDROOM PRIVACY	A40S	Push-button locking. Can be unlocked from outside with small screwdriver. Turning inside knob/lever or closing door releases button.	F76
ENTRANCE	A53PD	Turn/Push-button locking: pushing and turning button locks outside knob, requiring use of key until button is manually unlocked. Push-button locking: pushing button locks outside knob until unlocked by key or by turning inside knob/lever. (1 cylinder)	F109
CLASSROOM	A70PD	Outside knob locked and unlocked by key. Inside knob always unlocked. (1 cylinder)	F84
COMMUNICATING	A79PD	Locked or unlocked by key from outside. Blank plate inside. (1 cylinder)	
STOREROOM	A80PD	Outside knob fixed. Entrance by key only. Inside knob always unlocked. (1 cylinder)	F86
HOTEL/MOTEL	A85PD	Outside knob fixed. Entrance by key only. Push-button in inside knob activates visual occupancy indicator, allowing only emergency master key to operate. Turning inside knob or closing door release visual occupancy indicator. Rotation of inside spanner-button provides lockout feature by keeping indicator activated. (1 cylinder)	F93
SINGLE DUMMY	A170	Dummy trim for one side of door. Used for door pull or as matching inactive trim.	

SCHLAGE

AL SERIES

For Standard Duty Commercial

- ANSI A156.2-1996 Series 4000, Grade 2.
- U.L. Listed for 3-hour Fire Doors.
- 3-Year Mechanical Warranty. (Exclusion: Key-in-lever used on educational facilities)
- Non-Handed.
- Heavy Duty Compression Springs.
- Stainless Steel Interlocking Spindle.
- Levers BOTH Sides.

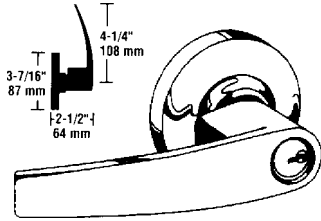

**JUPITER
(JUP)**

605, 613, 626
(NS: 606, 612, 619, 625)

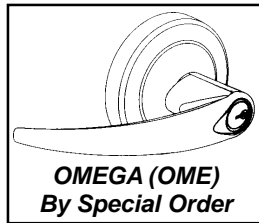

OMEGA (OME)
By Special Order

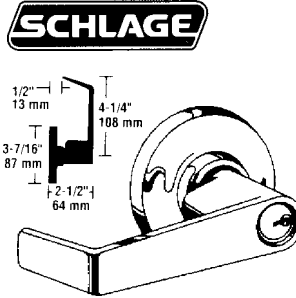

**SATURN
(SAT)**

605, 609, 612, 613, 619, 625, 626

(NS: 606)

Also stock BD, JD in 626



6 locks per case

Complies
with A.D.A.
requirements

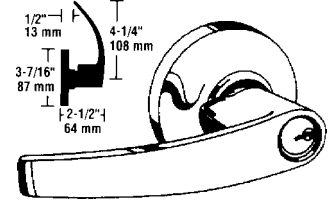

**NEPTUNE
(NEP)**

605, 613, 619, 626

(NS: 606, 609, 612, 625)

SPECIFICATIONS

- DOOR THICKNESS:** 1-3/8" to 1-7/8"
BACKSET: 2-3/4" sq. corner 1-1/8" wide face
STRIKE: 10-025
BORE: 2-1/8" x 1"
THROUGHBOLTS: 5/16" diam. 2-3/4" center to center.
ROSE: 3-7/16"
KEY BLANKS: 35-100- 5 pin
 35-101- 6 pin
KEYWAYS: PD-C Standard, 6-pin, keyed to 5 pin
 E, F Optional in most cases. EVEREST-C123 or C145 also available.
 LD-Less Cylinder-limited selection.
 JD-Less Full Size Interchangeable Core-limited selection.
 BD-Less SFIC-limited selection in SAT.
FINISHES: 605(US-3) Bright Brass, clear coated
 609(US-5) Antique Brass, clear coated
 612(US-10) Satin Bronze, clear coated
 613(US-10B) Oil Rubbed Bronze
 619(US-15) Satin Nickel
 625(US-26) Bright Chrome
 626(US-26D) Satin Chrome

To Order, Specify:

Function: **AL53PD** Entrance
 Design: **SAT** Saturn
 Finish: **605** Bright Brass
 Latch: **234** 2-3/4" Backset

Not all functions are available in all designs/finishes

Cylinder Options (Limited Selection-Please Call)

Just replace "PD" with...

LD- Less 6-Pin Cylinder.

JD- Less Full Size Interchangeable

Core. Pictured at right. (SAT 626)

BD- Less SFIC-Small Format I/C (SAT 626, 613 in AL53)



Function	No.	Operation	ANSI
PASSAGE	AL10S	Both levers always unlocked.	F75
BED/BEDROOM PRIVACY	AL40S	Push-button locking. Can be unlocked from outside with small screwdriver. Turning inside lever or closing door releases button.	F76
ENTRANCE/ OFFICE	AL50PD	Push-button locking: pushing button locks outside lever until unlocked by key or by turning inside lever. (1 cylinder)	F82
ENTRANCE	AL53PD	Turn/Push button locking: pushing and turning button locks outside lever requiring use of key until button is manually unlocked. Push-button locking: pushing button locks outside lever until unlocked by key or by turning inside lever. (1 cylinder)	F109
CLASSROOM	AL70PD	Outside lever locked and unlocked by key. Inside lever always unlocked. (1 cylinder)	F84
STOREROOM	AL80PD	Outside lever fixed. Entrance by key only. Inside lever always unlocked. (1 cylinder)	F86
SINGLE DUMMY	AL170	Single dummy trim for one side of door. Used for door pull or as matching inactive trim.	

(NS) Non-stock finish available as factory special order. Some finishes may have factory special handling charge.

606-Satin Brass, clear coated; 610-Bright Brass, Blackened, Bright Relieved; 611-Bright Bronze; 616-Antique Bronze, Satin Bronze, Blackened, Satin Relieved; 629-Bright Stainless Steel; 630-Satin Stainless Steel.

©ZIPF LOCK COMPANY

SCHLAGE

D SERIES KNOBS ND SERIES LEVERS

For Heavy Duty Commercial

- ANSI A156.2, 1996, Series 4000, Grade 1.
- 7-year Mechanical Warranty on ND levers. Levers both sides.
- 3-year Mechanical Warranty on D knobs.
- UL Listed for 3-hour Fire Door.

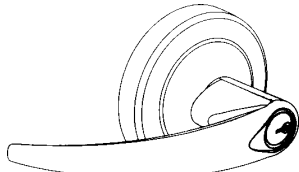

OMEGA (OME)
605, 613, 619, 626
(NS: 606, 612, 625)

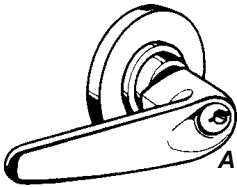

ATHENS (ATH)
605, 626
(NS: 606, 612, 613, 619, 625)

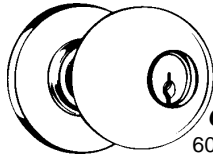

ORBIT (ORB)
605, 613, 625, 626
(NS: 606, 609, 610, 611, 612, 616, 629, 630)

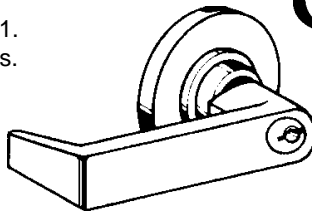

RHODES (RHO)
605, 612, 613, 619, 625, 626
(NS: 606)
Also stock BD, JD in 626



SPARTA (SPA)
605, 626
(NS: 606, 612, 613, 619, 625)

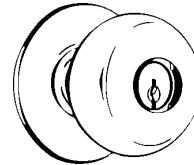

PLYMOUTH (PLY)
605, 612, 626
(NS: 606, 609, 610, 611, 613, 616, 625, 629, 630)

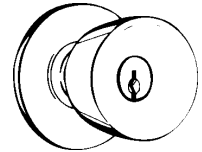

TULIP (TUL)
626
(NS: 605, 606, 609, 610, 611, 612, 613, 616, 625, 629, 630)



Lever Locks are handicapped approved

(NS) Non-stock finish available as factory special order.

Some finishes may have factory special handling charge.

606-Satin Brass; 609-Antique Brass; 610-Bright Brass, Blackened, Bright Relieved; 611-Bright Bronze; 616-Antique Bronze, Satin Bronze, Blackened, Satin Relieved; 629-Bright Stainless Steel; 630-Satin Stainless Steel.

To Order, Specify:

Function: **ND53PD** Entrance
Design: **RHO** Rhodes
Finish: **626** Satin Chrome
Latch: **234*** 2-3/4" Backset

Knob-D prefix
Lever-ND prefix

Not all functions are available in all designs/finishes

ND The change from D levers to ND levers is a rolling change effective November 10, 2003

Cylinder Options (Limited Selection-Please Call)

Just replace "PD" with...
LD- Less 6-Pin Cylinder. **23-030-C**
JD- Less Full Size Interchangeable Core. Pictured at right (RHO 626). **23-030-C123**
BD- Less SFIC-Small Format I/C (RHO 626) **23-030-C145**
23-030-E

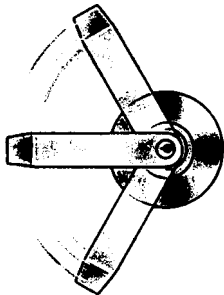

VANDLGARD™
Locked lever freely rotates up and down while remaining securely locked.
Functions: ND91PD, ND92PD, ND93PD, ND94PD and ND96PD.

Benefits/Features

- Extended Warranty
- Prohibits through bolt loosening
- Reduces lever wobble and play
- Resists vandalism
- Resists over-rotation of the lever

SPECIFICATIONS

See Spacer below for 1-3/8" door

DOOR THICKNESS: 1-3/8" to 2" (Knobs).
1-5/8" to 2-1/8" (Levers).

BACKSET: 2-3/4" standard, 2-3/8" available.
3-3/4" (price upcharge)

BORE: 2-1/8" x 1"

THROUGHBOLTS: On Levers: 5/16" diam. 2-3/4" center to center.

ROSE: 2-9/16" for knobs
3-7/16" for levers

KEY BLANKS: 35-100- 5 pin
35-101- 6 pin

KEYWAYS: PD-C Standard, 6-pin, keyed to 5 pin
E, F Optional in most cases. **EVEREST-** C123 or C145 also available.
LD- Less Cylinder-limited selection.
JD- Less Full Size Interchangeable Core-limited selection. (RHO 626).
BD- Less SFIC- limited selection in **RHO**.

FINISHES:
605(US-3) Bright Brass, clear coated
612(US-10) Satin Bronze, clear coated
613(US-10B) Oil Rubbed Bronze
619(US-15) Satin Nickel
625(US-26) Bright Chrome
626(US-26D) Satin Chrome

SPECIFY IF ASA STRIKE IS REQUIRED.

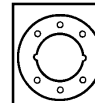

DJ-AR335 605, 613, 630
Spacer for installing lever lock on 1-3/8" door

*NOTE: On D & ND Series, 2-3/4" square face latch is standard. Specify if ASA strike is required.

©ZIPF LOCK COMPANY

SCHLAGE

D & ND SERIES FUNCTIONS

Function	No.	Operation	ANSI
PASSAGE	10S	Both knobs/levers always unlocked.	F75
ELECTRICALLY LOCKED-EXIT	12DEL	Outside lever continuously locked electrically. Unlocked by switch or power failure. Auxiliary latch deadlocks latchbolt when door is closed. Inside lever always free for immediate exit.	
ELECTRICALLY UNLOCKED-EXIT	12DEU	Outside lever continuously locked until unlocked by electric current. Auxiliary latch deadlocks latchbolt when door is closed. Inside lever always free for immediate exit.	
EXIT	25D	Blank plate outside. Inside knob always unlocked. FOR 1-3/4" THICK DOOR ONLY.	
BED/BEDROOM PRIVACY	40S	Push-button locking. Can be opened from outside with small screwdriver. Turning inside knob/lever or closing door releases button.	F76
HOSPITAL PRIVACY	44S	Push-button locking. Unlocked from outside by turning emergency turnbutton. Turning inside lever or closing door releases button.	
ENTRANCE	50PD	Push button locking. Push-button locks outside lever until unlocked with key or by turning inside lever. (1 cylinder)	F82
ENTRANCE	53PD	Turn/Push button locking: pushing and turning button locks outside knob/lever, requiring use of key until button is manually unlocked. Push-button locking: pushing button locks outside knob/lever until unlocked with key or by turning inside knob/lever. (1 cylinder)	F109
ENTRANCE with Vandlgard™	92PD	Turn/Push-button locking: pushing and turning button disengages outside lever, requiring use of key until button is manually unlocked. Push-button locking: pushing button disengages outside lever until unlocked by key or by turning inside lever. Vandlgard is designed to disengage outside spindle from latch when in locked condition. (1 cylinder)	F109
ENTRANCE/OFFICE with Vandlgard™	91PD	Push-button locking. Push-button disengages outside lever until unlocked with key or by turning inside lever. Vandlgard is designed to disengage outside spindle from latch when in locked condition. (1 cylinder)	F82
VESTIBULE-CLASSROOM SECURITY	60PD	Latch retracted by key from outside when outside knob/lever is locked by key in inside knob/lever. Inside knob/lever is always unlocked. (2 cylinders)	F88
VESTIBULE/CLASSROOM SECURITY with Vandlgard™	93PD	Latch retracted by key from outside when outside lever is disengaged by key in inside lever. Inside lever always unlocked. Vandlgard is designed to disengage outside spindle from latch when in locked condition. (2 cylinders)	F88
STORE	66PD*	Key in either knob/lever locks or unlocks both knobs/levers. (2 cylinders)	F91
CLASSROOM	70PD	Outside knob/lever locked and unlocked by key. Inside knob/lever always unlocked. (1 cyl)	F84
CLASSROOM with Vandlgard™	94PD	Outside lever disengaged and unlocked by key. Inside lever always unlocked. Vandlgard is designed to disengage outside spindle from latch when in locked condition. (1 cylinder)	F84
COMMUNICATING	72PD*	Key in either knob locks or unlocks each knob independently. (2 cylinders)	F80
CORRIDOR	73PD	Locked or unlocked by key from outside. Push-button locking from inside. Turning inside knob/lever or closing door releases button. When outside lever locked by key it can only be unlocked by key. Inside lever always unlocked. (1 cylinder)	F90
STOREROOM	80PD	Outside knob/lever fixed. Entrance by key only. Inside knob/lever always unlocked. (1 cyl)	F86
STOREROOM with Vandlgard™	96PD	Outside lever always disengaged. Entrance by key only. Inside lever always unlocked. Vandlgard is designed to disengage outside spindle from latch when in locked condition. (1 cyl)	F86
ELECTRICALLY LOCKED	80PDEL	Outside knob continuously locked electrically. Unlocked by key outside or by switch or power failure. Auxiliary latch deadlocks latchbolt when door is closed. Inside knob always free for immediate exit. Amps .15; Volts 24 AC only. (1 cylinder) - Fail Safe.	
ELECTRICALLY UNLOCKED	80PDEU	Outside knob continuously locked until unlocked by key or electric current. Auxiliary latch deadlocks latchbolt when door is closed. Inside knob always free for immediate exit. Amps .15; Volts 24 AC. Amps .35; Volts 24DC. DC operation intermittent duty only. (1 cyl) - Fail Secure.	
INSTITUTION	82PD*	Both knobs/levers fixed. Entrance by key in either knob/lever. (2 cylinders)	F87
SINGLE DUMMY	170	Single dummy trim for one side of door. Used for door pull or as matching inactive trim.	

***Caution:** Double cylinder locks on residences and any door in any structure which is used for egress are a life safety hazard in times of emergency and their use is not recommended. Installation should be in accordance with existing codes only.

• Not all functions are available in all designs •

ZIPF LOCK COMPANY
175
 (PL-10)

SCHLAGE

6 locks per case

FE SERIES ELECTRONICS



Keypad Entry Locks

- ANSI A156.2-2003 bored locks and latches.
- ANSI A156.5-2001 Grade 2 cylinders.
- Residential Lifetime Mechanical Warranty.
- Residential Lifetime Finish Warranty.
- FCC Part 15, CE Mark.

FE575 Auto-Lock

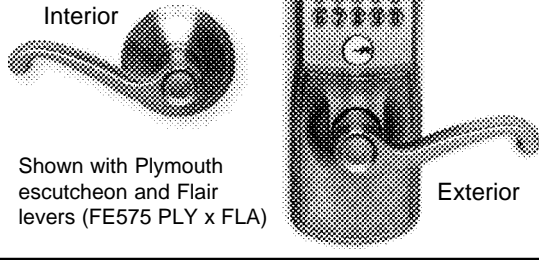

FE595 Flex-Lock

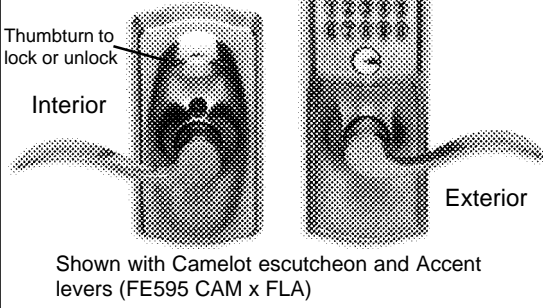

FE575 Auto-Lock Feature

Schlage Keypad locks with the Auto-Lock feature automatically re-lock five seconds after use, providing complete confidence and protection for your family and valuables. Ideal for use on doors leading to basement stairways, storage and utility rooms, workshops and more.

FE595 Flex-Lock Feature

Schlage Keypad locks with the Flex-Lock feature allow homeowners to choose whether their door remains locked (with a code required for entry) or unlocked (no code required for entry) simply by rotating the inside thumbturn. This added layer of protection ensures that valuables and family members are safe, and ideal for garage entry doors, home offices, storage rooms and more.



Accent(ACC)

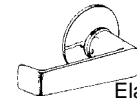

Elan(ELA)

Function	Design	Finish	Inside Design	Escutcheon
FE575	CAM	***	ACC	Flair(FLA)
FE575	PLY	626	ELA	
FE575	PLY	***	FLA	
FE575	PLY	626	JAZ	Georgian(GEO)
FE575	PLY	505	PLY	
FE595	CAM	***	ACC	Jazz(JAZ)
FE595	CAM	505	GEO	
FE595	CAM	609	GEO	
FE595	CAM	619	GEO	
FE595	PLY	626	ELA	
FE595	PLY	***	FLA	
FE595	PLY	626	JAZ	Plymouth(PLY)

***Specify Finish: 505,609,613,619,620,625,626,716

**Example—
FE595 CAM 620 ACC**

SPECIFICATIONS

DOOR THICKNESS:	1-3/8" to 1-3/4"
BACKSET:	3AL-Adjustable latch for 2-3/8", 2-3/4" with Square Face/Round Face/Drive-in. Both RCS, SCS.
STRIKE:	2-1/8" X 7/8" standard latch
BORE:	2-1/8" x 1" drive-in latch
KEY BLANK:	35-100-C
KEYWAYS:	C Standard, 5-pin
FINISHES:	505 ULTIMA™, Bright Brass 609(US-5) Antique Brass, clear coated 613(US-10B) Oil Rubbed Bronze* 619(US-15) Satin Nickel Plated 620(US-15A) Antique Pewter 625(US-26) Bright Chrome 626(US-26D) Satin Chrome 716 New Aged Bronze

*613 is a living finish and will wear and change appearance over time

Security and Quality

- Grade 2 ANSI/BHMA certified
- Patented commercial grade clutching motor drive: tested to one million cycles.
- Vandal resistant clutching lever and knob design.
- Code control, 6-digit programming code required to add and delete user codes.
- Warning code sounds after 4 incorrect codes entered; keypad disabled for 30 seconds.
- Mechanical key override: patent pending.

Convenience

- Convenient keyless access; no keys to hide, lose or forget.
- Pre-set with random 6-digit programming code and two random 4-digit user codes.
- 19 user code capacity; 10,000 user code combinations.
- Easily programmed right at the keypad; no need to remove inside escutcheon.
- Blue LEDs illuminate the keypad on demand.
- Reversible levers for left- or right-handed doors.
- Emergency exit feature; allows for panic-free exit.
- Locks can be rekeyed to match existing locks.
- 9-volt alkaline battery included.

©ZIPF LOCK COMPANY

SCHLAGE

FA SERIES

ACCENTS™
Timeless beauty

8 locks per case

For Standard Duty Residential

- ANSI A156.2, 1996, Series 4000, Grade 2.
- Residential Lifetime Mechanical Warranty.
- Residential Lifetime Finish Warranty.
- Field reversible levers (FA10, FA40, FA51).

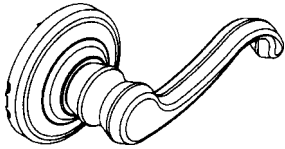

CALLINGTON (CLT)
505, 605, 609, 613,
619, 620, 625, 626, 716
(FA170 Specify Hand)

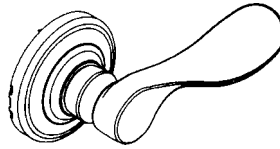

CHAMPAGNE (CHP)
505, 605, 609, 613,
619, 620, 625, 626, 716
(FA170 Specify Hand)

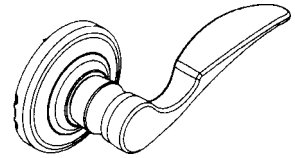

ST ANNES (STA)
505, 605, 609, 613,
619, 620, 625, 626, 716
(FA170 Specify Hand)

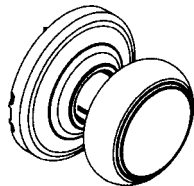

ANDOVER (AND)
505, 605, 609, 613,
619, 620, 625, 626, 716

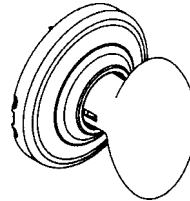

DANBURY (DNB)
505, 605, 609, 613,
619, 620, 625, 626, 716

Function	No.	Operation	ANSI
PASSAGE	FA10	Both knobs/levers are always unlocked.	F75
BATH/BEDROOM PRIVACY	FA40	Push-button locking. Can be opened from outside with small circular tool. Turning inside knob/lever releases button.	F76
ENTRANCE	FA51	Turn button locking. Unlocked by key outside or by turn button inside. Inside lever/knob always unlocked.	F81
SINGLE DUMMY	FA170	Single dummy trim for one side of door. Used for door pull or as matching inactive trim.	

To Order, Specify:

Function: **FA51** Entrance
Design: **CLT** Callington
Finish: **605** Bright Brass
* Handing required on CHP, CLT, STA dummy.

SPECIFICATIONS

DOOR THICKNESS: 1-3/8" to 1-3/4"
BACKSET: 3AL-Adjustable latch for 2-3/8", 2-3/4" with Square Face/Round Face/Drive-in.
STRIKE: Both RCS, SCS.
BORE: 2-1/8" X 7/8" standard latch
2-1/8" x 1" drive-in latch
ROSE: 2-3/4"
KEY BLANK: 35-025-C 5 pin Accents Bow
KEYWAYS: C Standard, 5-pin
FINISHES:
505 ULTIMA™, Bright Brass
605 (US-3) Bright Brass, clear coated
609 (US-5) Antique Brass, clear coated
613 (US-10B) Oil Rubbed Bronze*
619 (US-15) Satin Nickel Plated
620 (US-15A) Antique Pewter
625 (US-26) Bright Chrome
626 (US-26D) Satin Chrome
716 New Aged Bronze

*613 is a living finish and will wear and change appearance over time

BA SERIES

8 locks per case

For Standard Duty Residential

- ANSI A156.5, 2001, Grade 2 auxiliary lock
- Residential Lifetime Mechanical Warranty.
- Residential Lifetime Finish Warranty.
- Door frame strike reinforcer with 3" screws.
- 7/8" wrought brass, reinforced trim ring with security inserts.

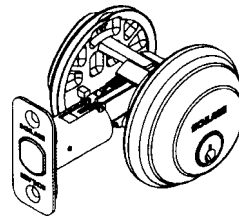

Stock No.	Description
BA360	Single Cylinder
BA362	Double Cylinder

505, 605, 609, 613, 619, 620, 625, 626, 716

TO ORDER, SPECIFY:

Stock No.	Finish (example)
BA360	619

SPECIFICATIONS

DOOR THICKNESS: 1-3/8" to 2"
BACKSET: 3AL-Triple Option Adjustable Latch
STRIKE: Both RCS, SCS.
BORE: 2-1/8" X 7/8" standard latch
2-1/8" x 1" drive-in latch
FINISHES: Same as FA locks.

©ZIPF LOCK COMPANY

SCHLAGE

F SERIES



20 locks per case
Dummy - 30 locks per case

For Standard Duty Residential

- ANSI A156.2, 1996, Series 4000, Grade 2.
- Residential Lifetime Mechanical Warranty.
- Residential 10-year Finish Warranty (605/609/626).
- Residential 505-Ultima™ Lifetime Finish.
- Residential Artisan Lifetime Finish(613/619/620/625).



Levers meet applicable
ADA accessibility
codes.



ACCENT (ACC)

605, 609, 613, 619, 620, 625, 716
(F10, F51 also 505)
(Specify Hand - LH or RH)

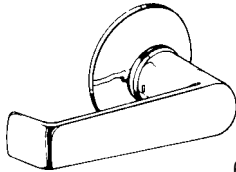

ELAN (ELA)

605, 609, 626
(Keyed Locks have
knob outside)

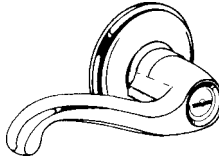

FLAIR (FLA)

605, 609, 613, 619, 620, 625, 626, 716
(F10, F51 also 505)
(Specify Hand - LH or RH)

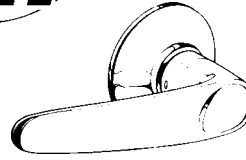

JAZZ (JAZ)

605, 619
(Keyed Locks have
knob outside)

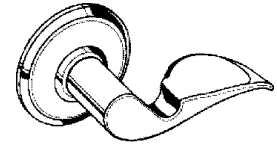

AVANTI (AVA)

605, 609, 613, 619, 620, 625, 716
(F10, F51 also 505)
(Specify Hand for dummy)

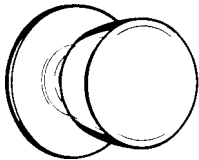

BELL (BEL)

605, 609, 626
(F10, F51 also 505)
(Also F40 in 605/625)

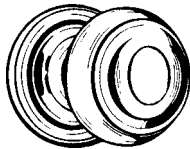

GEORGIAN (GEO)

605, 609, 619, 620, 625, 716
(F10, F51, F54 also 505)

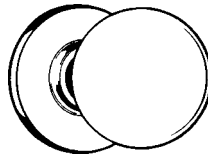

ORBIT (ORB)

605, 609, 613, 619, 620,
625, 626
(F10, F51, F54 also 505)

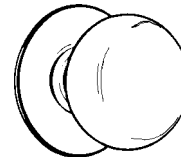

PLYMOUTH (PLY)

605, 613, 619, 620, 625,
626, 716
(F10, F51, F54 also 505)
(Also F40 in 605/625)

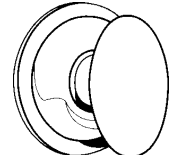

SIENNA (SIE)

605, 609, 613, 619,
620, 625, 716
(F10, F51 also 505)

Function	No.	Operation	ANSI
PASSAGE	F10	Both knobs/levers are always unlocked.	F75
BATH/BEDROOM PRIVACY	F40	Push-button locking. Can be opened from outside with small circular tool. Turning inside knob/lever releases button.	F76
ENTRANCE	F51	Unlocked by key from outside when outer knob/lever is locked by turn button in inside knob/lever. Inside knob/lever always unlocked.	F81
ENTRANCE	F54	Key from outside or turnbutton inside locks or unlocks <u>both knobs</u> . (knobs only)	
STOREROOM	F80	Outside knob fixed. Entrance by key only. Inside knob/lever always unlocked.	F86
SINGLE DUMMY	F170	Single dummy trim for one side of door. Used for door pull or as matching inactive trim.	

SPECIFICATIONS

DOOR THICKNESS: 1-3/8" to 1-7/8"
***BACKSET:** 3AL-Adjustable latch for 2-3/8", 2-3/4" with Square Face/Round Face/Drive-in. AL-Adjustable 2-3/8" to 2-3/4" SCL. RCL-Round Corner Adjustable Latch.
***STRIKE:** RCS, SCS. 3AL has both strikes. *Selection may be limited.
BORE: 2-1/8" X 7/8" standard latch
 2-1/8" x 1" drive-in latch
ROSE: 2-3/4"
KEY BLANKS: 35-100- 5 pin
KEYWAYS: C Standard, 5-pin
FINISHES:
505 Bright Brass, ULTIMA™-Lifetime
605 (US-3) Bright Brass, clear coated
609 (US-5) Antique Brass, clear coated
613 (US-10B) Oil Rubbed Bronze-Artisan Lifetime
619 (US-15) Satin Nickel Plated-Artisan Lifetime

To Order, Specify:

Function: **F51** Entrance
 Design: **FLA** Flair
 Finish: **605** Bright Brass
 *Handing: **RH** Right Hand
 Latch: **3AL Triple Option Latch
 * Handing required on ACC, AVA, FLA, dummies. (SEE PAGE 186 FOR DETERMINING HANDING)
 Please specify latch. Selection may be limited. Some locks **ONLY available with Triple Option Latch (3AL).
Not all functions are available in all designs/finishes

620 (US-15A) Antique Pewter-Artisan Lifetime
625 (US-26) Bright Chrome-Artisan Lifetime
626 (US-26D) Satin Chrome
716 New Aged Bronze

*613 is a living finish and will wear and change appearance over time

©ZIPF LOCK COMPANY

SCHLAGE

S SERIES FLAIR

For Heavy Duty Residential and Standard Duty Commercial

- ANSI A156.2, 1996, Series 4000, Grade 2.
- U.L. Listed for 3-hour Fire Door.
- 3-year Mechanical Warranty. (Exclusion: Key-in-lever used on educational facilities)
- Levers BOTH Sides.

SCHLAGE

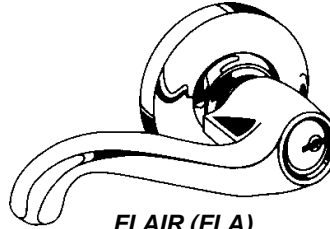

FLAIR (FLA)
605
(Specify Handing)



JUP, NEP, SAT
designs
Available by
Special Order

6 locks per case



Complies with
A.D.A.
requirements

To Order, Specify:

Function: **S51PD** Entrance

Design: **FLA** Flair

Finish: **605** Bright Brass

Handing: **RH** Right Hand

NOTE: Lock only available with Universal (AL) backset latch to fit either 2-3/8" or 2-3/4" backsets.

Cylinder Options (Limited Selection-Please Call)

Just replace "PD" with...

LD- Less 6-Pin Cylinder.

COMMERCIAL APPLICATIONS
CONTRACTOR

Apollo CSV see below.

SPECIFICATIONS

DOOR THICKNESS: 1-3/8" to 2".

1-3/8" to 1-7/8" for S40D.

BACKSET: Adjustable 2-3/8" to 2-3/4" SCL.

BORE: 2-1/8" x 7/8"

ROSE: 2-9/16".

KEY BLANKS: 35-100- 5 pin

35-101- 6 pin

KEYWAYS: PD-C Standard, 6-pin, keyed to 5 pin

E, F Optional in most cases. **EVEREST-** C123 or C145 also available.

LD-Less Cylinder-limited selection.

FINISHES: **605** (US-3) Bright Brass, clear coated

<u>Function</u>	<u>No.</u>	<u>Operation</u>	<u>ANSI</u>
PASSAGE	S10D	Both levers always unlocked.	F75
BATH/BEDROOM PRIVACY	S40D	Push-button locking. Can be unlocked from outside with small circular tool. Turning inside lever releases button. Closing the door does not release button (restoring).	F76
ENTRANCE	S51PD	Unlocked by key from outside when outside lever is locked by turn-button in inside lever. Inside lever always unlocked. (1 cylinder)	F81
CLASSROOM	S70PD	Outside lever locked and unlocked by key. Inside lever always unlocked. (1 cylinder)	F84
STOREROOM	S80PD	Outside lever fixed. Entrance by key only. Inside lever always unlocked. (1 cylinder)	F86
SINGLE DUMMY	S170	Single dummy trim for one side of door. Used for door pull or as matching inactive trim.	

CONTRACTOR SERIES

COMMERCIAL APPLICATIONS
CONTRACTOR

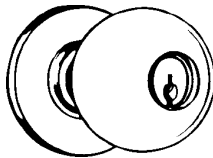

ORBIT (ORB)



ANSI Grade 2
U.L. Listed
Nickel Silver Keys and pins
T-strike 10-001
Die Cast Cylinder

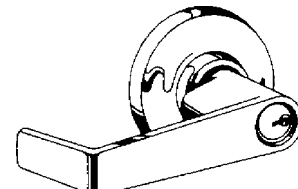

APOLLO (APO)

<u>Stock No.</u>	<u>Function</u>
A53CSV ORB 605 234	Entrance
A53CSV ORB 626 234	Entrance
A80CSV ORB 626 234	Storeroom

<u>Stock No.</u>	<u>Function</u>
S51CSV APO 605 AL	Entrance
S51CSV APO 626 AL	Entrance

©ZIPF LOCK COMPANY

WEISER

WELCOME HOME SERIES

For Standard Duty

- ANSI A156.2, Series 4000, Grade 2.
- Residential Lifetime Mechanical warranty.
- Residential Lifetime Finish warranty.

WEISER LOCK™

Welcome Home SERIES®

24 Locks per case.
Dummy = 24 locks.

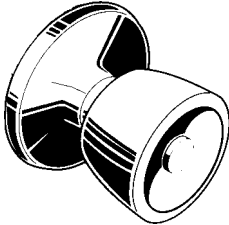

BEVERLY(B)
US-3, 5, 26D

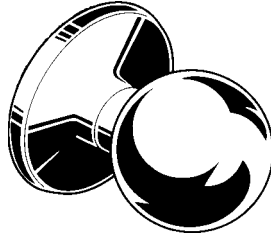

HUNTINGTON(H)
US-3
*US-5, 26, 26D
Limited Supply

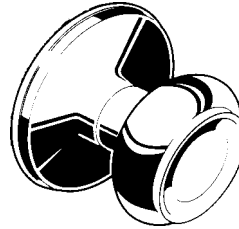

PHOENIX(P)
US-3, 5, 11P, 12, 15

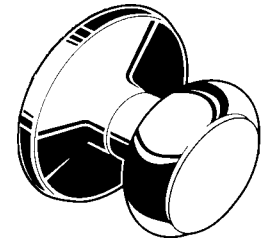

TROY(T)
US-3, 5, 11P, 15, 26D

<u>Function</u>	<u>No.</u>	<u>Operation</u>
DUMMY KNOB	A12	Single Knob, wood screw mounting.
HALL/CLOSET	A100	Latch bolt operated by knob from either side, both knobs always free.
BED/BATH	A300	Push and turn knob locking inside; knob with emergency release opening outside.
BED/BATH	A330	Turn button locking inside; knob with emergency release opening outside.
FRONT/BACK	A500	Keyed knob outside; push and turn knob locking inside, deadlocking latch standard.
FRONT/BACK	A530	Keyed knob outside; push and turn button locking inside. Deadlocking latch.
STOREROOM	A580	Keyed knob outside; outside knob always rigid; inside knob always free. Deadlocking latch.

SPECIFICATIONS

DOOR THICKNESS:	1-3/8" to 1-3/4"	
BACKSET:	Adjustable 2-3/8" to 2-3/4"	
BORE:	2-1/8" x 1"	
ROSE:	2-5/8"	
FINISHES:	US-3^B	Bright Brass
	US-5	Antique Brass, oxidized, hand relieved and highlighted
	US-11P	Venetian Bronze™
	US-12	Tuscan Copper™
	US-15	Satin Nickel
	US-26^B	Bright Chrome
	US-26D^B	Satin Chrome

^BBrilliance Finish is standard on exterior side of locks in the following functions: A500, A530 and A580

HOW TO ORDER: Specify,

Function:	A500	Front/Back
Design:	B	Beverly
Finish:	US-3	Bright Brass
*Latch:	AL	Adjustable

Not all functions are available in all designs/finishes.
*Weiser Lock will be switching over to 6AL Universal latch. This latch includes drive-in latch with square corner and round corner faceplates. Most locks will be switching to round corner strikes (RCS-R1).

WEISER

WELCOME HOME SERIES

For Standard Duty

- ANSI A156.2, Series 4000, Grade 2.
- Residential Lifetime Mechanical warranty.
- Residential Lifetime Finish warranty.

WEISER LOCK™

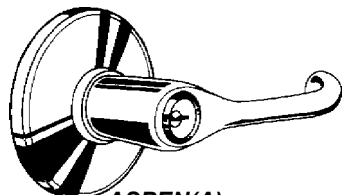

ASPEN(A)
US-3, 11P, 12, 15

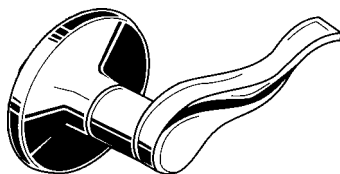

CORSAIR(C)
US-3, 5, 15
(Specify Hand LH - RH)

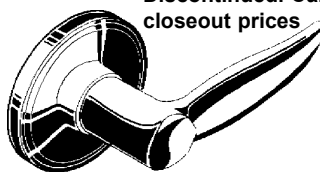

GALIANO(G)
US-3

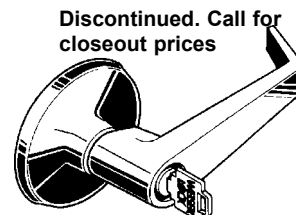

DANE(D)
US-3, 26D

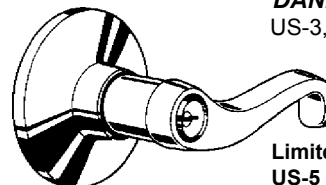

VALENCIA(V)
US-3, 15
(Specify Hand LH - RH)

Limited supply of US-5

12 Locks per case.
Dummy = 12 locks.

Discontinued. Call for closeout prices

Welcome Home SERIES®

Function	No.	Operation
DUMMY LEVER	LA12	Single lever, wood screw mounting.
HALL/CLOSET	LA100	Latch bolt operated by lever from either side, both levers always free.
BED/BATH	LA330	Turn button locking inside; lever with emergency release opening outside.
FRONT/BACK	LA530	Keyed knob outside; push and turn button locking inside. Deadlocking latch.
KEYED LEVER	LA535	Latch bolt operated by lever from either side, except when outside lever is locked by key outside or turn button inside. Locking button must be returned to unlocked position by key outside or turn button inside to release inner and outer lever. Deadlocking latch.

¹ Determine Hand of Door:

Diagrams show outside of door.

LH-the hinge is on the left side of the door.

RH-the hinge is on the right side of the door.

¹ To determine the hand of a dummy lever, face the side of the door it will be used on. If hinges are on left, order L.H., if hinges are on right, order R.H.

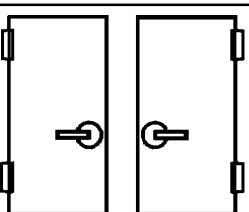

Specify outside knob when ordering LA530 function:

ASPEN	P3, P11P, P12, P15, T3, T15.
CORSAIR	B5, P3, P5, P15, T3, T5, T15.
GALIANO	B3.
VALENCIA	B3, H3, P15, T15.

HOW TO ORDER: Specify,

Function:	LA530	Front/Back
Outside Knob:	B	Beverly [‡]
Lever Design:	V	Valencia
Finish:	US-3	Bright Brass
*Hand:	LH	Left Hand
**Latch:	AL	Adjustable

Not all functions are available in all designs/finishes.

[‡] Only need to specify if ordering NLA530 function.

*Specify hand when ordering Corsair or Valencia levers.

**Weiser Lock will be switching over to 6AL Universal latch. This latch includes drive-in latch with square corner and round corner faceplates. Most locks will be switching to round corner strikes (RCS-R1). LA535 available with fixed face latch only.

	SPECIFICATIONS	
DOOR THICKNESS:	1-3/8" to 1-3/4"	
BACKSET:	Adjustable 2-3/8" to 2-3/4"	
BORE:	2-1/8" x 1"	
ROSE:	2-5/8"	
	2-15/16" on LA535 lever	
FINISHES:	US-3[‡]	Bright Brass
	US-5	Antique Brass, oxidized, hand relieved and highlighted
	US-11P	Venetian Bronze™
	US-12	Tuscan Copper™
	US-15	Satin Nickel
	US-26[‡]	Bright Chrome
	US-26D[‡]	Satin Chrome

[‡]Brilliance Finish is standard on exterior side of locks in the following functions: LA530 & LA535.

©ZIPF LOCK COMPANY

WEISER

24 Locks per case.

WELCOME HOME SERIES WEISERBOLT

WEISER LOCK™

Welcome Home SERIES®

For Standard Duty

- 1" Projection deadbolt latch with 1/4" dia. hardened steel free-turning roller.
- Residential Lifetime Mechanical warranty.
- Residential Lifetime Finish warranty

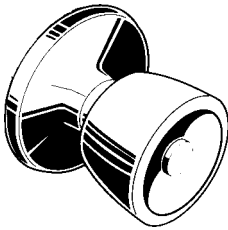

BEVERLY(B)
US-3, 5

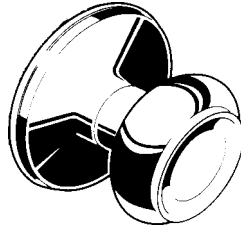

PHOENIX(P)
US-3

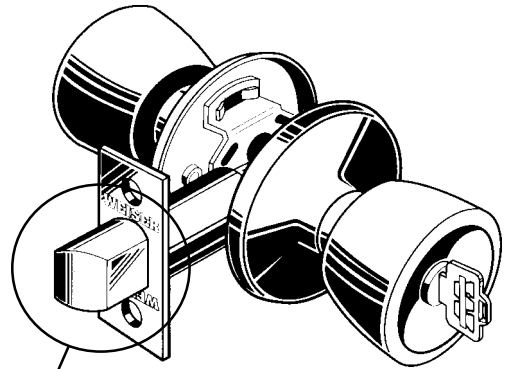

**ADJUSTABLE LATCH
BOLT AND DEADBOLT
IN ONE**

Function
FRONT/BACK

No.
DA5170

Operation

1/2" latch bolt operated by knob from either side. 1" projection deadbolt operated by turn button inside and key outside. Outside knob turns free in locked position. Key in outer trim or turning inside knob returns latch to spring position. Inside knob always free.

SPECIFICATIONS

DOOR THICKNESS: 1-5/8" to 1-7/8"

BACKSET: Adjustable 2-3/8" to 2-3/4"

BORE: 2-1/8" x 1"

ROSE: 2-5/8"

STRIKE: A13251

FINISHES: **US-3^P** Bright Brass
US-5 Antique Brass, oxidized,
hand relieved and highlighted

^PBrilliance Finish is standard on exterior side of locks in the following function: DA5170

HOW TO ORDER: Specify,

Function:	DA5170	Front/Back
Design:	B	Beverly
Finish:	US-3	Bright Brass
Latch:	AL	Adjustable

**Strike for Weiserbolt
ZL-507 STRIKE ONLY**

WEISER

ELEMENTS SERIES

For Standard Duty

- ANSI A156.2, Series 4000, Grade 3.
- Residential 25-Year Mechanical Warranty.
- Residential 10-Year Finish Warranty.

elements SERIES™

WEISER LOCK™

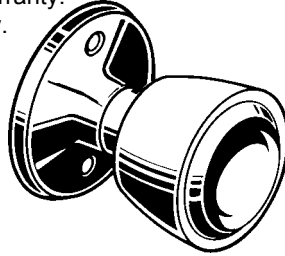

RICHMOND (R)
US-3, 5,
26D(Discontinued)

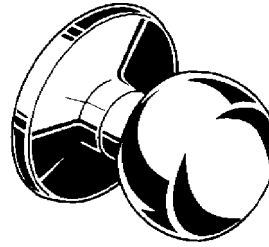

FAIRFAX (F)
US-3

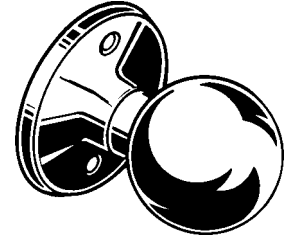

YORK (Y)
US-3, 15

24 Locks per case.
Dummy = 24 locks.
Lever = 12 locks.

Function	No.	Operation
DUMMY KNOB	AC12	Single Knob, wood screw mounting.
HALL/CLOSET	AC100	Latch bolt operated by knob from either side, both knobs always free.
BED/BATH	AC300	Push and turn knob locking inside; knob with emergency release opening outside.
BED/BATH	AC330	Turn button inside locking; knob with emergency release opening outside.
FRONT/BACK	AC500	Keyed knob outside; push and turn knob locking inside. Deadlocking latch standard.
FRONT/BACK	AC530	Keyed knob outside; push button locking inside. Deadlocking latch.

SPECIFICATIONS

DOOR THICKNESS:	1-3/8" to 1-3/4"	
BACKSET:	Adjustable 2-3/8" to 2-3/4"	
BORE:	2-1/8" x 1"	
ROSE:	2-5/8"	
FINISHES:	US-3	Bright Brass
	US-5	Antique Brass, oxidized, hand relieved and highlighted
	US-15	Satin Nickel
	US-26D	Satin Chrome

HOW TO ORDER: Specify,

Function:	LC330	Bed/Bath
Design:	M	Monterey
Finish:	US-3	Bright Brass
*Hand:	LH	Left Hand
**Latch:	AL	Adjustable

Not all functions are available in all designs/finishes.
*Specify hand when ordering Monterey lever.
**Weiser Lock will be switching over to 6AL Universal latch. This latch includes drive-in latch with square corner and round corner faceplates. Most locks will be switching to round corner strikes (RCS-R1).

¹ Determine Hand of Door:

Diagrams show outside of door.

LH-the hinge is on the left side of the door.

RH-the hinge is on the right side of the door.

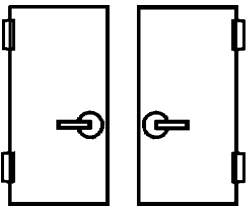

¹ To determine the hand of a dummy lever, face the side of the door it will be used on. If hinges are on left, order L.H., if hinges are on right, order R.H.

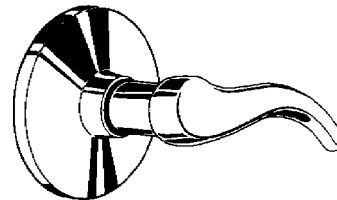

MONTEREY (M)
US-3, 15
(Specify Hand LH - RH)

Function	No.	Operation
DUMMY LEVER	LC12	Single Lever, wood screw mounting.
HALL/CLOSET	LC100	Latch bolt operated by lever from either side, both levers always free.
BED/BATH	LC330	Turn button inside locking; lever with emergency release opening outside.
KEYED LEVER	LC535	Latch bolt operated by lever from either side, except when outside lever is locked by key outside or turn button inside. Locking button must be returned to unlocked position by key outside or turn button inside to release inner and outer lever. Deadlocking latch.

©ZIPF LOCK COMPANY

YALE

10 locks per case.

5300 SERIES

For Residential and Light Commercial

- ANSI A156.2, Series 4000, Grade 2

Yale

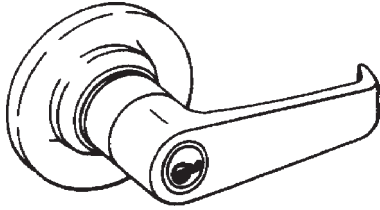

AUGUSTA(AU)
US-3, 26D

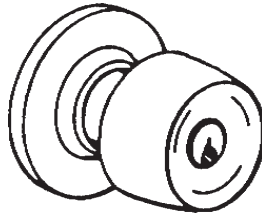

BRANDYWINE(BR)
US-3, 26D

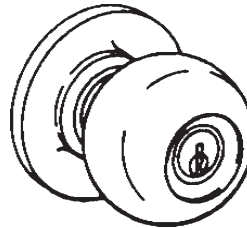

CAROLINA(CA)
US-3, 10B, 26D

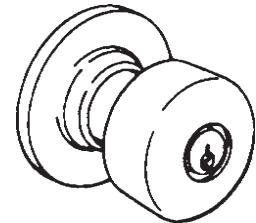

LITCHFIELD(LF)
US-3, 26D

	Knob Function#	Lever Function#	Operation
PASSAGE	\$5301	\$5301LN	For doors that do not require locking. Either knob/lever operates the latchbolt at all times.
PRIVACY	—	\$5302LN	For lavatory or other privacy doors. Either lever operates latch bolt unless outside lever is locked by pushbutton inside. Button automatically releases when inside lever is turned or door closed. Emergency key inserted and turned in hole in outside lever will unlock door. Inside lever always active.
ENTRANCE	\$5307	5307LN	For Entrance or Office doors. Latchbolt by knob/lever either side, except when outside knob/lever is locked. When outside knob/lever is locked latchbolt is operated by key outside and knob/lever inside. Outside knob/lever is locked by pushing turn button in inside knob/lever (Automatically releases when inside knob/lever is turned or key is rotated in locking outside knob/lever). Outside knob/lever may be retained in locked position by pushing and rotating turn button, not released until turn button is manually returned to the vertical position. Deadlocking latchbolt.
Still Stock:			
	AU5307LN 26D 234		
	CA5307 26D 234		
	LF5307 26D 234		
STOREROOM	\$5305	\$5305LN	For Storeroom, Closet, Utility or Exit Doors. Outside knob/lever always rigid at all times. Latchbolt by key outside, knob/lever inside. Deadlocking latchbolt.
CLASSROOM	\$5308	\$5308LN	For Classroom, Office or Utility doors. Latchbolt by knob/lever either side, except when outside knob/lever is set by key outside. Knob/lever inside always active. Deadlocking latchbolt.
ENTRANCE *LF only	\$5316*	—	For Entrance doors requiring optional locking of inside knob. Latchbolt operated by knob or key from inside and by key only from outside. Inside knob may be locked or unlocked by full turn of key in inside knob. Outside knob always locked when key is removed.

HOW TO ORDER: Specify,

Design: **LF** Litchfield
 Function: **5307** Entrance
 Finish: **26D** Satin Chrome
 Latch: **234** 2-3/4" Backset

LF-5307 26D 234

(Not all finishes/functions stocked in all designs.)

SPECIFICATIONS

DOOR THICKNESS: 1-3/8" to 2"
BACKSET: 2-3/8" or 2-3/4"
 US-10B—2-3/4" only
BORE: 2-1/8" x 1"
FINISHES: **US-3** Bright Brass
US-10B Satin Bronze,
 Oxidized & Oil Rubbed
US-26D Satin Chrome

©ZIPF LOCK COMPANY

238 v1
(PL-15)

**NOTE: Many Yale locks are being phased out. Call for super closeout prices.
 (We also have Schlage locks with Yale keyways)**

YALE

10 locks per case.

5400 SERIES

For Commercial Duty

- ANSI A156.2, Series 4000, Grade 1

Yale

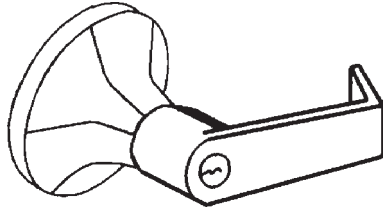

AUGUSTA(AU)
US-3, 26D

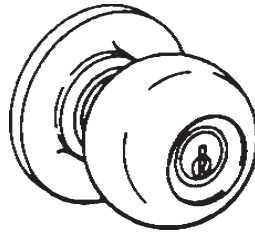

CAROLINA(CA)
US-10B, 26D

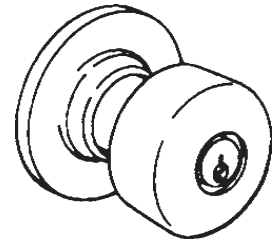

LITCHFIELD(LF)
US-10, 26D

	Knob Function#	Lever Function#	Operation
PASSAGE	\$5401	\$5401LN	For doors that do not require locking. Either knob/lever operates the latchbolt at all times.
PRIVACY	—	\$5402LN ^F	For lavatory or other privacy doors. Either lever operates latch bolt unless outside lever is locked by pushbutton inside. Button automatically releases when inside lever is turned or door closed. Emergency key inserted and turned in hole in outside lever will unlock door. Inside lever always active.
ENTRANCE	\$5407	5407LN ^F	For Entrance or Office doors. Latchbolt by knob/lever either side, except when outside knob/lever is locked. When outside knob/lever is locked latchbolt is operated by key outside and knob/lever inside. Outside knob/lever is locked by pushing turn button in inside knob/lever (Automatically releases when inside knob/lever is turned or key is rotated in locking outside knob/lever). Outside knob/lever may be retained in locked position by pushing and rotating turn button, not released until turn button is manually returned to the vertical position. Deadlocking latchbolt.
Still Stock:			
	AU5407LN 26D 234		
	AU5408LN 26D 234		
	LF5407 26D 234		
STOREROOM	\$5405	\$5405LN ^F	For Storeroom, Closet, Utility or Exit Doors. Outside knob/lever always rigid at all times. Latchbolt by key outside, knob/lever inside. Deadlocking latchbolt.
CLASSROOM	\$5408	5408LN ^F	For Classroom, Office or Utility doors. Latchbolt by knob/lever either side, except when outside knob/lever is set by key outside. Knob/lever inside always active. Deadlocking latchbolt.
STORE DOOR *LF only	\$5419*	—	For Store entrance or communicating doors. Either knob operates latchbolt (except when both knobs are locked simultaneously by key in either knob). Deadlocking latchbolt.
COMMUNICATING	\$5421* *LF only	—	For Communicating or Store entrance doors. Either knob operates latchbolt (except when key in either knob locks or unlocks the knob independently of the other). Should be used only on offices or rooms with multiple entry. Deadlocking latchbolt.
ASYLUM *LF only	\$5430*	—	For Utility, Asylum or Institutional doors. Latchbolt by key both sides. Rigid knob/rose both sides for use as pulls. Deadlocking latchbolt.

HOW TO ORDER: Specify,

Design: **LF** Litchfield
 Function: **5407** Entrance
 Finish: **US-26D** Satin Chrome
 Latch: **234** 2-3/4" Backset

LF-5407 US-26D

(Not all finishes/functions stocked in all designs.)

^FOutside lever is free wheeling when locked.

SPECIFICATIONS

DOOR THICKNESS: 1-3/8" to 2"
BACKSET: 2-3/4"
BORE: 2-1/8" x 1"
FINISHES: **US-10** Satin Bronze
US-10B Satin Bronze,
 Oxidized & Oil Rubbed
US-26D Satin Chrome

©ZIPF LOCK COMPANY

**NOTE: Many Yale locks are being phased out. Call for super closeout prices.
 (We also have Schlage locks with Yale keyways)**

239_{v1}
 (PL-15)