

# ARROW



12 locks per case.

**US-3 discontinued-**  
Call for closeout prices

## ANSI A156.5, Grade 1

- Two piece housing with free spinning outer ring
- Concealed screws on double cylinder function
- 1" throw, solid steel deadbolt w/hardened steel pin
- 2 strikes supplied, one for steel frame, one for wood frame

### SPECIFICATIONS

**DOOR THICKNESS:** 1-3/8" to 1-3/4"  
**BACKSET:** 2-3/4"  
**BOLT THROW:** 1"  
**BORE:** 2-1/8"  
**KEYWAY:** Arrow "A" drilled for 6 (pinned to 5)  
**FINISH:** **US-3** Polished Brass  
**US-26D** Satin Chrome

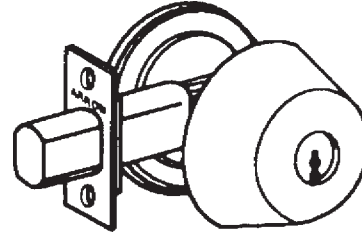

**D61** Single Cylinder  
**D62** Double Cylinder



12 locks per case.

## ANSI A156.5, Grade 1

- Same features as D60 Series above.

### SPECIFICATIONS

**DOOR THICKNESS:** 1-3/8" to 1-3/4"  
**BACKSET:** 2-3/4"  
**BOLT THROW:** 1"  
**BORE:** 2-1/8"  
**KEYWAY:** Uses interchangeable core  
(not included-order separately)  
**FINISH:** **US-26D** Satin Chrome

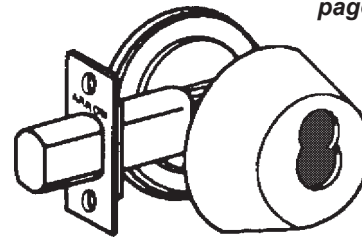

**D61-IC** Single Cylinder  
**D62-IC** Double Cylinder

*Less cores. See  
page 112 for cores.*



24 locks per case.

## ANSI A156.5, Grade 2

- Two piece housing with free spinning outer ring
- Concealed screws on double cylinder function
- Full 1/4" steel thru-bolts
- 1" throw, solid steel deadbolt w/hardened steel pin
- 2 strikes supplied, one for steel frame, one for wood frame

### SPECIFICATIONS

**DOOR THICKNESS:** 1-3/8" to 1-3/4"  
**BACKSET:** 2-3/8", 2-3/4"  
**BOLT THROW:** 1"  
**BORE:** 2-1/8"  
**KEYWAY:** Arrow "A" drilled for 6 (pinned to 5)  
E61, E62 in 3 & 26D also available with "C"  
**FINISH:** **US-3** Polished Brass  
**US-5A** Antique Brass  
**US-26D** Satin Chrome

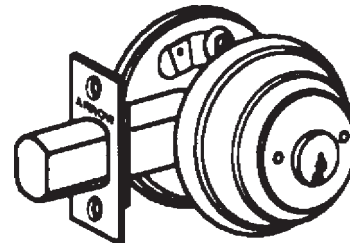

**E61** Single Cylinder  
**E62** Double Cylinder

# ASSA

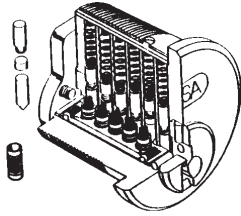

# ASSA

**WHEN KEY CONTROL AND SECURITY ARE A MUST!!!**

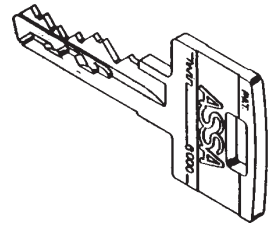

**PHYSICAL SECURITY—**

**PICK RESISTANT.** The ASSA Twin resist picking by any commonly known method. Two independent locking mechanisms ensure optimum pick resistance. Inactive “dummy” grooves in the side pins catch the side bar when improperly positioned. When rotational force is applied in a conventional picking attempt, the mushroom-shaped drivers are caught by counter milling in the cylinder plug.

**DRILL RESISTANT.** Drills are sometimes used to destroy brass cylinders and open locks. Vital points in the ASSA Twin/6000 and Twin Exclusive cylinders are protected by case-hardened, drill resistant inserts. All pins are nickel silver or stainless steel.

**KEYS AND KEY CONTROL—**

The ASSA Twin/6000 and Twin Exclusive keys are precision-crafted security tools. Two sets of bittings, or key cuts, operate the double locking mechanisms. Detail and quality are evident. Even the back of the keys are rounded for smooth operation and minimal wear. The enlarged key bow accommodates use by manually impaired people, and the unusual strength of the key virtually eliminates breakage.

The ingenious design of the ASSA Twin/6000, Twin Exclusive deadlocks and cylinders have earned patents in the United States and many other countries. Patents are crucial in the effort to eliminate unauthorized duplicate keys and maintain key control.

**Any infringement of the ASSA patent rights will be forcefully defended in the courts.**

**THE ALPHA SYSTEM (Twin/6000) AND ALPHA TWIN EXCLUSIVE (TE)**

**Four key control programs featuring the ASSA Twin/6000 and Twin Exclusive Cylinders.**

|                  |                       |   |
|------------------|-----------------------|---|
| <u>Twin/6000</u> | <u>Twin Exclusive</u> |   |
| <b>DELTA</b>     | <b>TED</b>            | Zipf Lock Company Distributor's keyway  |
| <b>GAMMA</b>     | <b>TEL</b>            | Locksmith keyways with local area restriction. Initial order required*        |
| <b>BETA</b>      | <b>TER</b>            | Locksmith keyways with extended regional restriction. Initial order required* |
| <b>ALPHA</b>     | <b>TEE</b>            | Regional or Nationally exclusive keyways for large end-users.*                |

\*Written agreement and initial order required. Contact us for details.



# ASSA

**FEATURES:**

- ASTM F 1577 6.6 Certified, Grade 1
- U.L. 437
- Hardhat™ to prevent physical attack
- Hardened bolt with full 1" throw
- Free spinning guard collars to prevent wrenching
- 1/4" Aircraft strength steel mounting bolts
- High Security solid brass ASSA cylinder
- Patented key control

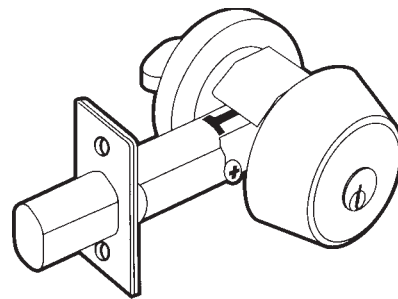

**NEW**

**SPECIFICATIONS**

**DOOR THICKNESS:** 1-3/8" to 2"  
**BACKSET:** 2-3/4"  
**BOLT THROW:** 1"  
**BORE:** 1-3/4"  
 (Will work in 2-1/8" bore)

**FINISHES:**  
**605** Bright Brass  
**626** Satin Chrome

|                                     |                 |                       |
|-------------------------------------|-----------------|-----------------------|
| <b>Twin/6000</b>                    |                 | <b>Twin Exclusive</b> |
| <u>Keyway</u>                       | <u>Function</u> | <u>Keyway</u>         |
| <b>6000</b>                         | Single Cylinder | <b>E6000</b>          |
| <b>6000DC</b>                       | Double Cylinder | <b>E6000DC</b>        |
| •All sub-assembled, no sidebar(SNS) |                 |                       |

•Also available in more restricted keyways. Call for details.

©ZIPF LOCK COMPANY

**114**<sub>v1</sub>  
(PL-3)

**V10 Series in stock is discontinued - Call for closeout prices**

# CAL-ROYAL

## CRB800 SERIES

### Maximum Security Heavy Duty Deadbolt

- ANSI A156.5, Grade 1.
- 1-year Mechanical Warranty.
- 1" Throw High Strength Steel Alloy Deadbolt With 1/4" Free Spinning Anti-saw Pin.
- Free Turning, Wrench-resistant Tapered Cylinder Ring.
- Cylinder Recesses Into Door to Resist Blows Attempting to Move the Lock.
- Steel Plate Mounting.
- Strike: 3" Screws with Wood Frame Reinforcer Greatly Strengthens Door Frames.
- **Solid Brass 6-pin Cylinder. "C" Keyway.**

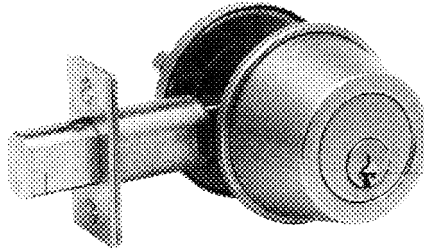

## CAL-ROYAL

20 locks per case

*With Standard Cylinder—*

| <u>Stock No.</u> | <u>Description</u> |
|------------------|--------------------|
| CRB-800          | Single Cylinder    |
| CRB-700          | Double Cylinder    |

*\*\*For Interchangeable Core—*

| <u>Stock No.</u> | <u>Description</u> |
|------------------|--------------------|
| IC-CRB-800       | Single Cylinder    |
| IC-CRB-700       | Double Cylinder    |

**\*\*Cores not included - order separately.**

**See below for cores.** 912-333-1111 (0513562110)

# CAL-ROYAL

## T300 SERIES

# CAL-ROYAL

20 locks per case

### Heavy Duty Deadbolt

- ANSI A156.5, Grade 2.
- 1-year Mechanical Warranty.
- 1" Throw High Strength Steel Alloy Deadbolt With Anti-saw Pin
- Cylinder Recesses Into Door to Resist Blows Attempting to Move the Lock.
- **Solid Brass 6-pin Cylinder. "C" Keyway.**

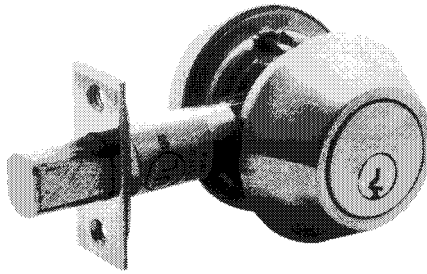

| <u>Stock No.</u> | <u>Description</u> |
|------------------|--------------------|
| *T360            | Single Cylinder    |
| *T362            | Double Cylinder    |

### SPECIFICATIONS

|                        |   |
|------------------------|---|
| <b>DOOR THICKNESS:</b> | 1-3/8" to 1-3/4"  |
| <b>BACKSET:</b>        | Adjustable 2-3/8" or 2-3/4" with square corner face.  |
| <b>STRIKE:</b>         | Square corner, 1-1/8" x 2-3/4"  |
| <b>BOLT THROW:</b>     | 1"  |
| <b>BORE:</b>           | 2-1/8" x 1"   |
| <b>KEYWAY:</b>         | 6 pin solid brass "C" keyway<br>Furnished keyed different (KD)  |
| <b>FINISHES:</b>       | <b>US3</b> (605) Bright Brass<br><b>10B</b> (613) Oil Rubbed Bronze<br><b>26</b> (625) Bright Chrome<br><b>26D</b> (626) Satin Chrome |

## LSD SERIES

# CAL-ROYAL

20 locks per case

### Standard Duty Deadbolt

- ANSI Grade 3.
- 1-year Mechanical Warranty.
- 1" Throw Bolt With 1/4" Free Spinning Anti-cut Through Pin.
- Rotating Trim Ring.
- **Solid Brass 6-pin Cylinder. "C" Keyway. Rekeyable for Construction Keying.**

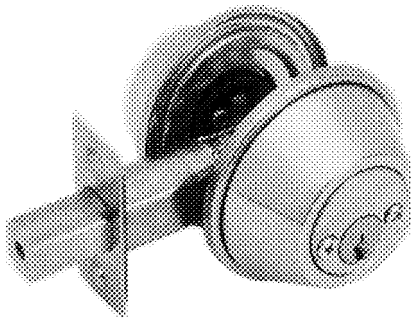

| <u>Stock No.</u> | <u>Description</u>            |
|------------------|-------------------------------|
| LSD-01           | Single Cylinder               |
| LSDD-88          | Double Cylinder<br>(pictured) |

### SPECIFICATIONS

|                        |   |
|------------------------|---|
| <b>DOOR THICKNESS:</b> | 1-3/8" to 1-3/4"  |
| <b>BACKSET:</b>        | Adjustable 2-3/8" or 2-3/4" with square corner face.  |
| <b>STRIKE:</b>         | Square corner, 1-1/8" x 2-3/4"  |
| <b>BOLT THROW:</b>     | 1"  |
| <b>BORE:</b>           | 2-1/8" x 1"   |
| <b>KEYWAY:</b>         | 6 pin solid brass "C" keyway<br>Furnished keyed different (KD)  |
| <b>FINISHES:</b>       | <b>US3</b> (605) Bright Brass<br><b>10B</b> (613) Oil Rubbed Bronze<br><b>32D</b> (630) Stainless Steel |

### To Order, Specify:

|  |                               |
|--|-------------------------------|
| Function:                                    | <b>LSD-01</b> Single Cylinder |
| Finish:                                      | <b>US3</b> Bright Brass       |
| Latch:                                       | <b>AL</b> Adjustable S.C.     |
| • All locks are stocked Keyed Different (KD) |                               |

# CORBIN/RUSSWIN

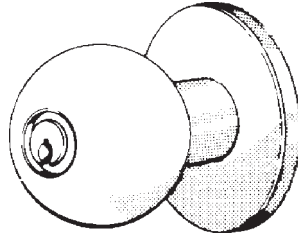

**GLOBAL  
(GWC)**  
613, 630

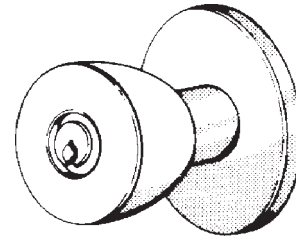

**BELMONT  
(BWC)**  
605, 612, 630

**FEATURES:**

- ANSI A156.2 Series 4000, Grade 2;
- U.L. Listed
- Reversible

**SPECIFICATIONS**

**DOOR THICKNESS:** 1-1/4" to 1-3/4"  
**BACKSET:** 2-3/4" square face  
**STRIKES:** Global—ASA  
 Belmont—"T" type  
**BORE:** 2-1/8" x 1"  
**ROSE:** 3"  
**KEYWAYS:** D1, L1 or 981  
**FINISHES:** **605** Bright Brass  
**612** Satin Bronze  
**613** Dark Oxidized Satin Bronze, oil rubbed  
**630** Satin Stainless Steel

*Call for GREAT closeout prices.*

|           |                  |                       |
|-----------|------------------|-----------------------|
| Function: | <b>RE-CK4451</b> | Entrance              |
| Design:   | <b>GWC</b>       | Global Design         |
| Finish:   | <b>630</b>       | Satin Stainless Steel |
| Keyway:   | <b>D1</b>        | D1 keyway             |

| <u>Function</u>  |                 | <u>Operation</u>   |
|--|-----------------|--|
| PASSAGE  | <b>\$CK4410</b> | Deadlocking latchbolt by knob either side. Both knobs always free. <b>(ANSI F75)</b>   |
| PRIVACY  | <b>\$CK4430</b> | Deadlocking latchbolt by knob either side. Outside knob locked by push button. Outside knob unlocked by turning slotted button outside, by rotating inside knob, or by closing door. <b>(ANSI F76)</b>   |
| ENTRANCE   | <b>\$CK4451</b> | Deadlocking latchbolt by either knob, except when turn button locks outside knob. Pushing turn button in locks outside knob, requiring use of key outside to unlock. Turning inside knob unlocks outside knob. Pushing in and turning button locks outside knob, requiring key at all times. Turning inside knob does not unlock outside knob until button is manually turned to unlocked position. Inside knob always free. <b>(ANSI F81)</b> |
| <div style="border: 1px solid black; padding: 5px; display: inline-block;">                     We still stock:<br/> <b>CK4451 GWC 630 D1</b> </div> |                 |  |
| CLASSROOM  | <b>\$CK4455</b> | Deadlocking latchbolt by knob either side, except when key outside locks outside knob. When outside knob is locked, latchbolt is operated by key outside or by rotating inside knob. Inside knob always free. <b>(ANSI F84)</b>  |
| STOREROOM  | <b>\$CK4457</b> | Deadlocking latchbolt by key in outside knob, or by rotating inside knob. Outside knob always rigid. Inside knob always free. <b>(ANSI F86)</b>  |

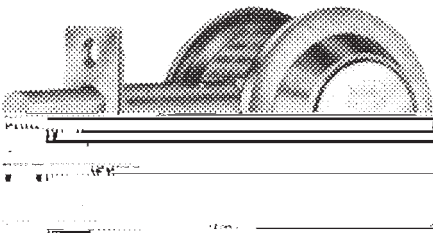

**\$DL3011** Single Cylinder (Key outside/blank plate inside)  
**\$DL3012** Double Cylinder

**DOOR THICKNESS:** 1-3/4"  
**BACKSET:** 2-3/4"  
**BORE:** 2-1/8"  
**BOLT THROW:** 1"  
**CYLINDER:** Mortise  
**KEYWAYS:** D1, L4  
**FINISH:** **613** Dark Oxidized Satin Bronze, Oil Rubbed  
**626** Satin Chromium Plated

*Call for GREAT closeout prices.*

|           |                  |                       |
|-----------|------------------|-----------------------|
| Function: | <b>RE-DL3013</b> | Single Cylinder       |
| Finish:   | <b>626</b>       | Satin Chromium Plated |
| Keyway:   | <b>D1</b>        | D1 keyway             |

# DEXTER

**DEXTER**  
by SCHLAGE

24 Locks per case

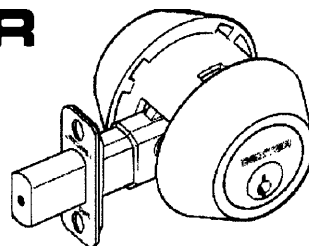

## For Residential Use

- ANSI A156.5, 1992, Grade 3.
- Residential 25-year Mechanical Warranty.
- Residential 5-year Finish Warranty.
- Rekeyable to Schlage Locks.
- Easy To Install.

| Function        | No.         | Operation  | ANSI         |
|-----------------|-------------|--|--------------|
| SINGLE CYLINDER | <b>JD60</b> | Deadbolt thrown or retracted by key from outside or by inside turn unit. Bolt automatically deadlocks when fully thrown. | <b>E2153</b> |
| DOUBLE CYLINDER | <b>JD62</b> | Deadbolt thrown or retracted by key from either side. Bolt automatically deadlocks when fully thrown.                    | <b>E2143</b> |

### To Order, Specify:

Function: **JD60** *Single Cylinder*  
 Finish: **605** *Bright Brass*  
 Latch: **AL** *Adjustable Latch*



### SPECIFICATIONS

**DOOR THICKNESS:** 1-3/8" to 1-3/4"  
**BACKSET:** AL-Adjustable for 2-3/8" or 2-3/4" with square and round corner face plates (16-048).  
**STRIKE:** Square corner strike (1-1/8" x 2-3/4").  
**BORE:** 2-1/8" x 1"  
**KEY BLANK:** J750-000  
**KEYWAY:** Schlage C Keyway, 5-pin  
**FINISHES:**  
**605**(US-3) Bright Brass  
**609**(US-5) Antique Brass  
**619** (US-15) Satin Nickel  
**620** (US-15A) Antique Pewter  
**625** (US-26) Bright Chrome  
**630**(US-32D) Satin Stainless Steel  
**716** New Aged Bronze

4 Locks per case

## For Residential Use

- ANSI A156.2, 1996, 4000 Series, Grade 3.
- Residential 25-year Mechanical Warranty.
- Residential 5-year Finish Warranty.
- Rekeyable to Schlage Locks.
- Easy To Install.

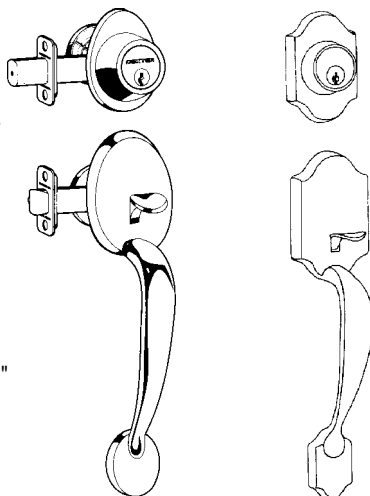

**BARCELONA (BAR)**

**PARIS (PRS)**

Center of handle hole to mounting screw: 8-5/8"

### Interior Packs

**JH59** For Locking Handles

### Interior Pack Designs

**BRY** 605,609,630

**CNA** 605,609,619,620,625,630

**DOV** 605,609,630

**LAS** 605,609,619,620,625,630,716

**MAR** 605,609,619,620,625,630

**STR** 605,619,716

**TOR** 605,609,619,620,625,630,716

### To Order, Specify:

*For handle-(exterior only)*

Handle No.: **JH58 PRS**

Finish: **619**

*For interior pack-(Listed above)*

Interior No.: **JH59**

Design: **LAS**

Finish: **619**

\*Handing: **LH**

\*Required on LAS lever design.

**DOOR THICK.:** 1-5/8" to 1-3/4"  
**BACKSET:** AL-Adjustable for 2-3/8" or 2-3/4" with square and round corner face plates.  
**STRIKE:** Square corner strike (1-1/8" x 2-3/4") for deadbolt. 1/4" Radius full lip for bottom latch. 2-1/8" x 1"  
**BORE:** 2-1/8" x 1"  
**KEY BLANK:** J750-000  
**KEYWAY:** Schlage C Keyway, 5-pin  
**FINISHES:**  
**605**(US-3) Bright Brass  
**609**(US-5) Antique Brass  
**619** (US-15) Satin Nickel  
**620** (US-15A) Antique Pewter  
**625** (US-26) Bright Chrome  
**630**(US-32D) Satin Stainless Steel  
**716** New Aged Bronze

### Function Description

**JH58** Locking Handle Exterior

**JH59** Locking Handle Interior

**JH193** Dummy Handleset w/interior\*

\*BAR exterior; BRY, CNA, LAS or STR interiors only.

©ZIPF LOCK COMPANY

# ILCO



- Patented deadlock with 1" throw bolt
- Heavy duty cylinder housing
- Heavy duty reinforced strike
- Bolt and housing interlock for maximum strength
- No exposed screws on double cylinder model
- Reinforced, tapered, free spinning collars
- Armored front shields cylinder set screws
- Uses solid brass mortise cylinders with Adams-Rite Cam
- Accepts virtually all manufacturers' mortise cylinders—conventional, interchangeable core or high security
- Two hardened steel rods in bolt resist sawing

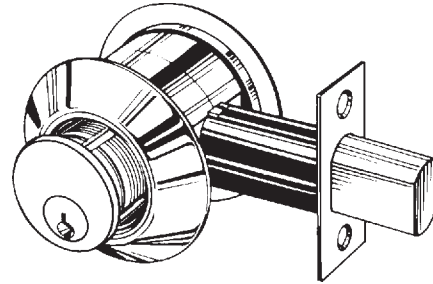

### Single Cylinder

|                 |                 |
|-----------------|-----------------|
| <b>LOR-4513</b> | 2-3/8"          |
| <b>LOR-4514</b> | 2-3/4"          |
| <b>LOR-4515</b> | 2-3/8" Drive-in |
| <b>LOR-4516</b> | 2-3/4" Drive-in |

### Double Cylinder

|                 |                 |
|-----------------|-----------------|
| <b>LOR-4523</b> | 2-3/8"          |
| <b>LOR-4524</b> | 2-3/4"          |
| <b>LOR-4525</b> | 2-3/8" Drive-in |
| <b>LOR-4526</b> | 2-3/4" Drive-in |

### SPECIFICATIONS

|                        |   |
|------------------------|---|
| <b>DOOR THICKNESS:</b> | 1-3/8" to 1-3/4"  |
| <b>BACKSET:</b>        | 2-3/8", 2-3/4"  |
| <b>BORE:</b>           | 2-1/8" x 1"   |
| <b>BOLT THROW:</b>     | 1"  |
| <b>CYLINDER:</b>       | Brass, 1"   |
| <b>FINISHES:</b>       | <b>03</b> Bright Brass<br><b>10B*</b> Oil-Rubbed Bronze<br><b>26D</b> Satin Chrome<br>*Limited supply |

## We stock locks with cylinder(s)...

### To Order, Specify:

Function: **4513** Sgl, 2-3/8"  
Finish: **-03** Polished Brass  
Cylinder: **-04** Schlage Keyway

*We stock the following keyways as complete locks: SC, YA\*. They have 5 pin cylinder(s). \*Limited with YA keyway.*

| Keyway                       | Keyway   |
|------------------------------|--|
| <b>-AA</b> Arrow             | <b>-RB</b> Russwin D1  |
| <b>-CA</b> Corbin 60         | <b>-SC</b> Schlage C   |
| <b>-CD</b> Corbin 59A1-A2    | <b>-SE</b> Schlage E   |
| <b>-CE</b> Corbin/Russwin L4 | <b>-SX</b> Schlage C/K   |
| <b>-FA</b> Segal 9 (1022)    | <b>-UA</b> Ilco X1054K   |
| <b>-GA</b> Sargent LA        | <b>-UE</b> Kaba 80   |
| <b>-GB</b> Sargent LA-LC     | <b>-WA</b> Weiser 1555   |
| <b>-GC</b> Sargent RA-RC     | <b>-XE</b> Dexter 67   |
| <b>-KS</b> Kwikset (1176)    | <b>-YA</b> Yale 8  |
| <b>-LA</b> Lockwood 1004     | <b>-YG</b> Yale GA   |
| <b>-NB</b> Composite HR1*    | *Can be keyed to Sargent U & S, Weslock, Harloc, SE1 and Lori L200. 1st pin at .216" |
| <b>-RA</b> Russwin 5981      |  |

• Keyways available subject to change •

## ...OR without cylinders

### To Order Lock, Specify:

Function: **4513** Sgl, 2-3/8"  
Finish: **-03** Polished Brass  
Keyway: **-00** Less Cylinder

## Cylinders—(if needed)

### To Order Cylinder, Specify:

Cylinder: **7185** For Single Cylinder  
Keyway: **-CA2** Corbin 60  
Finish: **-03** Polished Brass

### To Order Cylinders, Specify:

Cylinder: **7185** For Double Cylinder  
Keyway: **-CA2** Corbin 60  
Finish: **-03** Polished Brass  
**-KA2** 2 cylinders K.A.

*We stock the cylinders in the keyways listed at left. YOU MUST USE AN ADAMS RITE CAM WITH THESE CYLINDER-ORDER SEPARATELY if needed. These cylinder are 1-1/8", drilled 6 pin but keyed to 5.*

# KWIKSET



12 locks per case.

- ANSI A156.5, Grade 1.
- Titanium Alloy Throwbolt Core.
- Ultra-Strike Door Jamb Brace.
- Solid Steel Latch Face.
- Anti-Pick 6-pin Cylinder.
- Lifetime Mechanical Warranty.
- 10-year Finish Warranty.
- Lifetime Finish on LO3 finish.

Interior turnpiece meets 4.13.9 ADA requirements

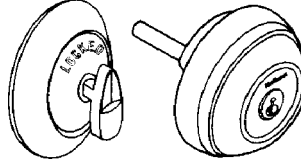

**980S** Single Cylinder  
US-L03, 5, 11P, 15, 15A, 26, 26D

**985S** Double Cylinder  
US-L03, 5, 11P, 15, 15A, 26, 26D

|                        |  |
|------------------------|--|
| <b>DOOR THICKNESS:</b> | <b>SPECIFICATIONS</b>                                |
| <b>BACKSET:</b>        | 1-3/4"   |
| <b>STRIKE:</b>         | Adjustable for 2-3/8", 2-3/4" with round corner face |
| <b>BORE:</b>           | 1-1/4" x 3-5/8" round corner                         |
| <b>CYLINDER:</b>       | 2-1/8" or 1-1/2" x 1"                                |
| <b>KEY BLANK:</b>      | 6-pin, includes 3 anti-pick pins                     |
| <b>FINISHES:</b>       | KW-81208 (KW-88260)                                  |
|                        | <b>US-LO3</b> (605E) Polished Brass-Lifetime         |
|                        | <b>US-5</b> (609) Antique Brass                      |
|                        | <b>US-11P</b> Venetian Bronze                        |
|                        | <b>US-15</b> (619) Satin Nickel                      |
|                        | <b>US-15A</b> (620) Antique Nickel                   |
|                        | <b>US-26</b> (625) Polished Chrome                   |
|                        | <b>US-26D</b> (626) Satin Chrome                     |

| <b>No.</b>  | <b>Description</b>  |
|-------------|---|
| <b>980S</b> | <b>Single Cylinder:</b> Deadbolt operated by key outside or thumbturn inside. |
| <b>985S</b> | <b>Double Cylinder:</b> Deadbolt operated by key both sides.                  |

**To Order, Specify:**

Function: **980S** *Single Cylinder*  
 Finish: **US-11P** *Venetian Bronze*  
 \*Latch: **RCAL** *Adjustable*  
 \*2-3/8" or 2-3/4" adjustable deadbolt Round Corner latch.

- ANSI A156.5 Grade 2.
- Maximum Security, Heavy Gauge Strike with Extra Long 3" Screws.
- Compatible with Kwikset's 5 Pin Keying Systems.
- Lifetime Mechanical Warranty.
- 10-year Finish Warranty.
- Lifetime Finish Warranty on **LO3** Finish.



12 locks per case.

Interior turnpiece meets 4.13.9 ADA requirements

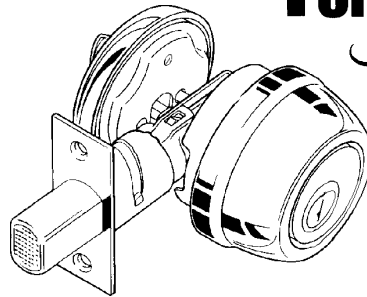

**780** Single Cylinder  
US-LO3, 3, 5, 10B, 11P, 15, 15A, 26, 26D

**785** Double Cylinder  
US-LO3, 3, 5, 10B, 11P, 15, 15A, 26, 26D

|                        |  |
|------------------------|--|
| <b>DOOR THICKNESS:</b> | <b>SPECIFICATIONS</b>                        |
| <b>BACKSET:</b>        | 1-3/8" to 1-3/4"                             |
| <b>BORE:</b>           | Adjustable for 2-3/8", 2-3/4"                |
| <b>STRIKE:</b>         | 2-1/8" or 1-1/2" x 1"                        |
| <b>BORE:</b>           | 6-pin  |
| <b>CYLINDER:</b>       | KW-81208 (KW-88260)                          |
| <b>KEY BLANK:</b>      | <b>US-LO3</b> (605E) Polished Brass-Lifetime |
| <b>FINISHES:</b>       | <b>US-3</b> (605) Polished Brass             |
|                        | <b>US-5</b> (609) Antique Brass              |
|                        | <b>US-10B</b> (613) Oil Rubbed Bronze        |
|                        | <b>US-11P</b> Venetian Bronze                |
|                        | <b>US-15</b> (619) Satin Nickel              |
|                        | <b>US-15A</b> (620) Antique Nickel           |
|                        | <b>US-26</b> (625) Polished Chrome           |
|                        | <b>US-26D</b> (626) Satin Chrome             |

| <b>No.</b> | <b>Description</b>  |
|------------|---|
| <b>780</b> | <b>Single Cylinder:</b> Deadbolt operated by key outside or thumbturn inside. |
| <b>785</b> | <b>Double Cylinder:</b> Deadbolt operated by key both sides.                  |

**To Order, Specify:**

Function: **785** *Double Cylinder*  
 Finish: **US-3** *Polished Brass*  
 \*Latch: **SCAL** *Adjustable Latch*  
 \*2-3/8" or 2-3/4" adjustable deadbolt latch is standard.  
 Specify **RCAL** for Round Corner Adjustable Latch.  
 Specify **SCAL** for Square Corner Adjustable Latch.  
 Specify **RFAL** for Round Face Adjustable Latch.

# KWIKSET



## Powerbolt Deadbolts

- 1" projection deadbolt latch with 1/4" diameter hardened steel free-turning roller.
- Easy to Install, Easy to Program, Easy to Use.
- Requires 4 "AA" alkaline batteries (not included).
- Residential 1-Year Electrical components warranty.
- Residential Lifetime Mechanical warranty.
- Residential 5-year Finish warranty.
- Residential Lifetime Finish warranty on LO3.

## Electronic Keyless Entry System

- Simply enter your personalized access code for convenient, quick and care-free entry.
- You may also program a temporary second code for a neighbor, cleaning crew, etc.
- Alarm sounds after 3 consecutive incorrect codes are entered.
- Easy-one touch locking.
- Heavy duty security deadbolt and strike plate resist break-ins.
- No wiring necessary (add 4 Alkaline "AA" batteries).
- Low battery indicator.
- Fits standard preparation on new doors.
- Easily replaces existing door hardware.

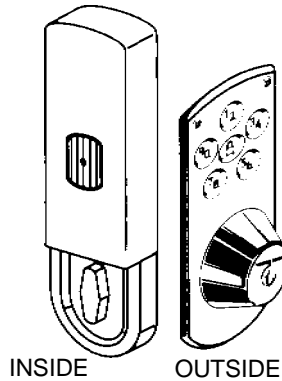

## SPECIFICATIONS

**DOOR THICKNESS:** 1-3/8" to 2"  
**BACKSET:** Adjustable 2-3/8" to 2-3/4"  
**BORE:** 2-1/8" x 1"  
**BOLT THROW:** 1"  
**FINISHES:** **US-LO3** Bright Brass - Lifetime  
**US-11P** Venetian Bronze  
**US-15** Satin Nickel

**Function:** **907** Single Cylinder  
**Finish:** **US-LO3** Bright Brass  
**Latch:** **AL** Adjustable

## Stock No. Operation

**907 Single Cylinder Deadbolt-**  
 Deadbolt latch retracted by entering security code outside and extended by pushing lock button outside. Deadbolt latch extended and retracted by T-Turn on inside. Using key outside will retract deadbolt latch if needed.

- ANSI A156.5, Grade 2.
- Full 1" Nickel Plated Steel Bolt.
- Solid Steel Strike.
- 5-pin cylinder.
- Lifetime Mechanical Warranty.
- 5-year Finish Warranty.
- Lifetime Finish Warranty on LO3 Finish.

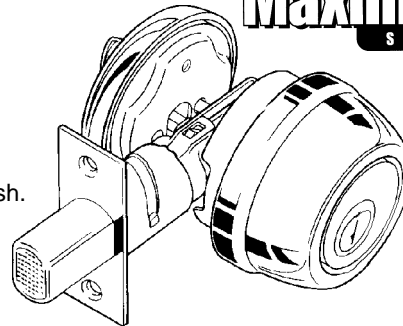

12 locks per case.



Interior turnpiece meets 4.13.9 ADA requirements

**970 Single Cylinder**  
 US-LO3, 3, 5, 11P, 15, 15A, 26, 26D

**975 Double Cylinder**  
 US-LO3, 3, 5, 11P, 15, 15A, 26, 26D

**DOOR THICKNESS:** 1-3/8" to 1-3/4"  
**BACKSET:** Adjustable for 2-3/8", 2-3/4"  
**BORE:** 2-1/8" or 1-1/2" x 1"  
**CYLINDER:** 5-pin  
**KEY BLANK:** KW-81063  
**FINISHES:** **US-LO3** (605E) Polished Brass-Lifetime  
**US-3** (605) Polished Brass  
**US-5** (609) Antique Brass  
**US-11P** Venetian Bronze  
**US-15** (619) Satin Nickel  
**US-15A** (620) Antique Nickel  
**US-26** (625) Polished Chrome  
**US-26D** (626) Satin Chrome

## No. Description

**970 Single Cylinder:** Deadbolt operated by key outside or thumbturn inside.  
**975 Double Cylinder:** Deadbolt operated by key both sides.

## To Order, Specify:

**Function:** **975** Double Cylinder  
**Finish:** **US-3** Polished Brass  
**\*Latch:** **AL** Adjustable

\*2-3/8" or 2-3/4" adjustable deadbolt latch is standard.  
 Specify **RCAL** for Round Corner Adjustable Latch.  
 Specify **SCAL** for Square Corner Adjustable Latch.  
 Specify **RFAL** for Round Face Adjustable Latch.

# KWIKSET

**Kwikset  
Security**

12 locks per case.

- ANSI A156.5, Grade 3.
- Limited Lifetime Mechanical Warranty
- 5-year Finish Warranty

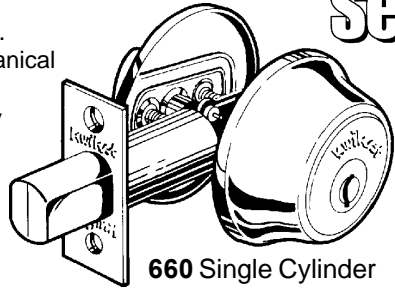

**660 Single Cylinder**  
US-3, 5, 11P, 15, 15A, 26, 26D

Interior turnpiece meets  
4.13.9 ADA requirements

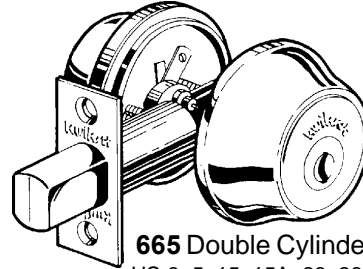

**665 Double Cylinder**  
US-3, 5, 15, 15A, 26, 26D

**No. Description**

- 660 Single Cylinder:** Deadbolt operated by key outside and thumbturn inside.
- 663 Thumbturn Only:** Deadbolt operated by thumbturn one side. No trim on other side.
- 665 Double Cylinder:** Deadbolt operated by key both sides.
- 667 Thumbturn x Plate:** Deadbolt operated by thumbturn on interior. Blank plate on exterior.

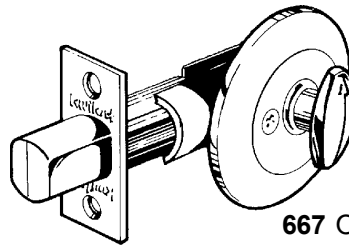

**663 One Sided (Pictured)**  
US-3, 5, 15, 15A, 26D

**667 One Sided w/Exterior Plate**  
US-3, 26D

**SPECIFICATIONS**

- DOOR THICKNESS:** 1-3/8" to 1-3/4"
- BACKSET:** Adjustable for 2-3/8", 2-3/4"  
663 has 2-3/8" fixed latch
- STRIKE:** 1" x 2-1/4"
- BORE:** 2-1/8" x 1"  
1-5/8" x 1" (For 663 Lock)  
2-1/8" or 1-1/2" x 1" (For 667 Lock)
- CYLINDER:** 5-pin
- KEY BLANK:** KW-81063
- FINISHES:**
  - US-3 (605)** Polished Brass
  - US-5 (609)** Antique Brass
  - US-11P** Venetian Bronze
  - US-15 (619)** Satin Nickel
  - US-15A (620)** Antique Nickel
  - US-26 (625)** Polished Chrome
  - US-26D (626)** Satin Chrome

**KW-664 Conversion Kit** US-3, 5, 26D

To convert a 663 to a 667. Kit has Exterior Plate, screws and torque blade.

**To Order, Specify:**

- Function: **665 Double Cylinder**
- Finish: **US-3 Polished Brass**
- \*Latch: **SCAL Adjustable Latch**
- \*2-3/8" or 2-3/4" adjustable deadbolt latch is standard.
- Specify **RCAL** for Round Corner Adjustable Latch.
- Specify **SCAL** for Square Corner Adjustable Latch.
- Specify **RFAL** for Round Face Adjustable Latch.

**Kwikset  
Security**

6 locks per case.

- Limited Lifetime Mechanical Warranty.
- 5-year Finish Warranty.
- 5-Pin Cylinder.
- Key Blank: KW-81063

**Contains:**

- 1 deadlock (660/665) and 1 entry lock (400P/400T), keyed alike.
- Adjustable latches— 2-3/8" or 2-3/4"
- Round Corner Strikes (RCS).
- Sets available Keyed in 2's (KA-2)

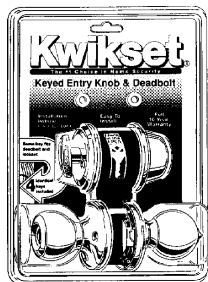

Limited supply of clear pack available. Only box pack will be available

**KEYED ENTRY KNOB...**

**W/Single Cylinder Deadlock**

- 690P 3 6AL** Polo in Polished Brass
- \$690P 5 6AL** Polo in Antique Brass
- 690P 15 6AL** Polo in Satin Nickel
- 690T 3 6AL** Tylo in Polished Brass

**W/Double Cylinder Deadlock**

- \$695P 3 6AL** Polo in Polished Brass
- \$695T 3 6AL** Tylo in Polished Brass
- \$695T 5 6AL** Tylo in Antique Brass

\$ Item discontinued. Call for closeout price.

# SCHLAGE

6 locks per case



## Keypad Deadbolts

- Grade 2 ANSI/BHMA certified.
- ANSI A156.5-2001 Grade 2 auxiliary locks.
- Residential Lifetime Mechanical Warranty.
- Residential Lifetime Finish Warranty.
- FCC Part 15, CE Mark.

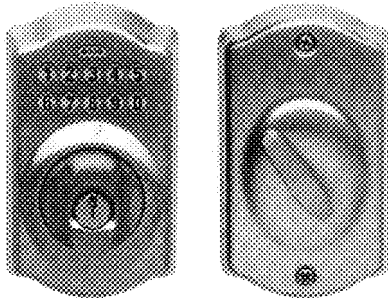

Shown with Camelot escutcheon

Exterior

Interior

### SPECIFICATIONS

- DOOR THICKNESS:** 1-3/8" to 1-3/4"  
**BACKSET:** 3AL-Adjustable latch for 2-3/8", 2-3/4" with Square Face/Round Face/Drive-in. SCS.  
**STRIKE:**  
**BORE:** 2-1/8" X 7/8" standard latch  
 2-1/8" x 1" drive-in latch  
**KEY BLANK:** 35-100-C  
**KEYWAYS:** C Standard, 5-pin  
**FINISHES:**
- |                    |                             |
|--------------------|-----------------------------|
| <b>505</b>         | ULTIMA™, Bright Brass       |
| <b>609(US-5)</b>   | Antique Brass, clear coated |
| <b>613(US-10B)</b> | Oil Rubbed Bronze*          |
| <b>619(US-15)</b>  | Satin Nickel Plated         |
| <b>620(US-15A)</b> | Antique Pewter              |
| <b>625(US-26)</b>  | Bright Chrome               |
| <b>626(US-26D)</b> | Satin Chrome                |
| <b>716</b>         | New Aged Bronze             |

\*613 is a living finish and will wear and change appearance over time

## BE365 with Turn-Lock Feature

Schlage Keypad Deadbolts bring professional grade security with the convenience of keyless access to the home. The innovative Turn-Lock feature allows the user to lock and leave without a key. Ideal for front, back and side entry doors where deadbolts are required.

## Security and Quality

- Grade 2 ANSI/BHMA certified
- Patented commercial grade clutching motor drive: tested to one million cycles.
- Vandal resistant free spinning deadbolt turn.
- Code control, 6-digit programming code required to add and delete user codes.
- Warning code sounds after 4 incorrect codes entered; keypad disabled for 30 seconds.
- Mechanical key override: patent pending.

## Convenience

- Convenient keyless access; no keys to hide, lose or forget.
- Pre-set with random 6-digit programming code and two random 4-digit user codes.
- 19 user code capacity; 10,000 user code combinations.
- Easily programmed right at the keypad; no need to remove inside escutcheon.
- Blue LEDs illuminate the keypad on demand.
- Locks can be rekeyed to match existing locks.
- 9-volt alkaline battery included.

| <u>Stock No.</u> | <u>Description</u>       |
|------------------|--------------------------|
| <b>BE365 CAM</b> | with Camelot escutcheon  |
| <b>BE365 PLY</b> | with Plymouth escutcheon |

•Specify finish when ordering.

## Keypad Front Entry (Bottom Half)

- Residential Lifetime Mechanical Warranty.
- Residential Lifetime Finish Warranty.

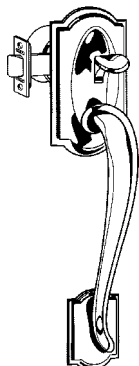

Camelot (CAM)

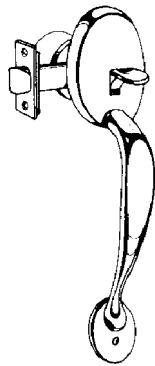

Plymouth (PLY)

| <u>Function</u> | <u>Escutcheon</u> |               | <u>Inside</u> |             | <u>***Finish (specify)</u>      |
|-----------------|-------------------|---------------|---------------|-------------|---------------------------------|
|                 | <u>Design</u>     | <u>Finish</u> | <u>Design</u> | <u>Hand</u> |                                 |
| <b>FE285</b>    | <b>CAM</b>        | ***           | <b>ACC</b>    | <b>LH</b>   | 505,619,620,716                 |
| <b>FE285</b>    | <b>CAM</b>        | ***           | <b>ACC</b>    | <b>RH</b>   | 505,619,620,716                 |
| <b>FE285</b>    | <b>CAM</b>        | ***           | <b>GEO</b>    |             | 505,609,619,716                 |
| <b>FE285</b>    | <b>PLY</b>        | ***           | <b>FLA</b>    | <b>LH</b>   | 505,609,613,619,620,625,626,716 |
| <b>FE285</b>    | <b>PLY</b>        | ***           | <b>FLA</b>    | <b>RH</b>   | 505,609,613,619,620,625,626,716 |
| <b>FE285</b>    | <b>PLY</b>        | ***           | <b>PLY</b>    |             | 505,613                         |



Accent(ACC)



Flair(FLA)



Georgian(GEO)

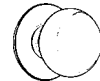

Plymouth(PLY)

©ZIPF LOCK COMPANY

# SCHLAGE

**ACCENTS™**  
Timeless beauty

8 locks per case

## For Standard Duty Residential

- ANSI A156.2, 1996, Series 4000, Grade 2.
- Residential Lifetime Mechanical Warranty.
- Residential Lifetime Finish Warranty.
- Field reversible levers (FA10, FA40, FA51).

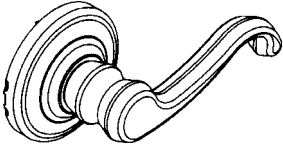

**CALLINGTON (CLT)**  
505, 605, 609, 613,  
619, 620, 625, 626, 716  
(FA170 Specify Hand)

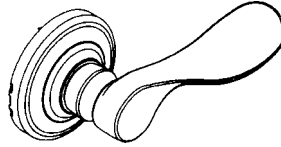

**CHAMPAGNE (CHP)**  
505, 605, 609, 613,  
619, 620, 625, 626, 716  
(FA170 Specify Hand)

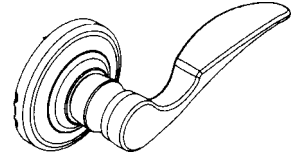

**ST ANNES (STA)**  
505, 605, 609, 613,  
619, 620, 625, 626, 716  
(FA170 Specify Hand)

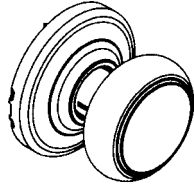

**ANDOVER (AND)**  
505, 605, 609, 613,  
619, 620, 625, 626, 716

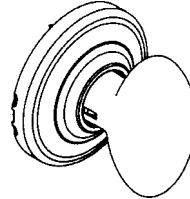

**DANBURY (DNB)**  
505, 605, 609, 613,  
619, 620, 625, 626, 716

| Function                | No.          | Operation  | ANSI       |
|-------------------------|--------------|--|------------|
| PASSAGE                 | <b>FA10</b>  | Both knobs/levers are always unlocked.   | <b>F75</b> |
| BATH/BEDROOM<br>PRIVACY | <b>FA40</b>  | Push-button locking. Can be opened from outside with small circular tool. Turning inside knob/lever releases button. | <b>F76</b> |
| ENTRANCE                | <b>FA51</b>  | Turn button locking. Unlocked by key outside or by turn button inside. Inside lever/knob always unlocked.            | <b>F81</b> |
| SINGLE DUMMY            | <b>FA170</b> | Single dummy trim for one side of door. Used for door pull or as matching inactive trim.                             |            |

### To Order, Specify:

Function: **FA51** Entrance  
Design: **CLT** Callington  
Finish: **605** Bright Brass  
\* Handing required on CHP, CLT, STA dummy.

### SPECIFICATIONS

**DOOR THICKNESS:** 1-3/8" to 1-3/4"  
**BACKSET:** 3AL-Adjustable latch for 2-3/8", 2-3/4" with Square Face/Round Face/Drive-in.  
**STRIKE:** Both RCS, SCS.  
**BORE:** 2-1/8" X 7/8" standard latch  
2-1/8" x 1" drive-in latch  
**ROSE:** 2-3/4"  
**KEY BLANK:** 35-025-C 5 pin Accents Bow  
**KEYWAYS:** C Standard, 5-pin  
**FINISHES:**  
**505** ULTIMA™, Bright Brass  
**605** (US-3) Bright Brass, clear coated  
**609** (US-5) Antique Brass, clear coated  
**613** (US-10B) Oil Rubbed Bronze\*  
**619** (US-15) Satin Nickel Plated  
**620** (US-15A) Antique Pewter  
**625** (US-26) Bright Chrome  
**626** (US-26D) Satin Chrome  
**716** New Aged Bronze

\*613 is a living finish and will wear and change appearance over time

8 locks per case

## For Standard Duty Residential

- ANSI A156.5, 2001, Grade 2 auxiliary lock
- Residential Lifetime Mechanical Warranty.
- Residential Lifetime Finish Warranty.
- Door frame strike reinforcer with 3" screws.
- 7/8" wrought brass, reinforced trim ring with security inserts.

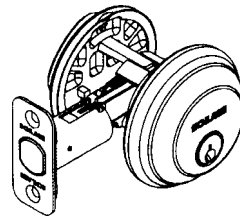

| Stock No.    | Description     |
|--------------|-----------------|
| <b>BA360</b> | Single Cylinder |
| <b>BA362</b> | Double Cylinder |

505, 605, 609, 613, 619, 620, 625, 626, 716

### TO ORDER, SPECIFY:

| Stock No.    | Finish (example) |
|--------------|------------------|
| <b>BA360</b> | <b>619</b>       |

### SPECIFICATIONS

**DOOR THICKNESS:** 1-3/8" to 2"  
**BACKSET:** 3AL-Triple Option Adjustable Latch  
**STRIKE:** Both RCS, SCS.  
**BORE:** 2-1/8" X 7/8" standard latch  
2-1/8" x 1" drive-in latch  
**FINISHES:** Same as FA locks.

# SCHLAGE

12 locks per case



## For Heavy Duty Residential & Commercial

- ANSI A156.5, 2001, Grade 1. U.L. Listed, 3-hour.
- 1" Throw Steel Alloy Deadbolt Containing a Hardened Steel Roller to Prevent Cutting.
- Solid Brass or Bronze Rotating Trim Ring.
- Mounting Screws Protected Against Drilling by Steel Balls.
- 3-year Mechanical Warranty.

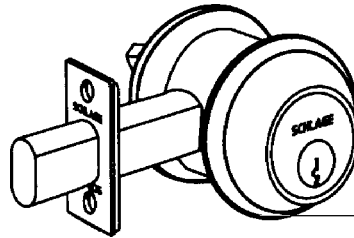

| Function        | No.           | Operation  | ANSI         |
|-----------------|---------------|--|--------------|
| SINGLE CYLINDER | <b>B660P</b>  | Deadbolt thrown or retracted by key from outside or by inside turn unit. Bolt automatically deadlocks when fully thrown. | <b>E2151</b> |
| DOUBLE CYLINDER | <b>B662P*</b> | Deadbolt thrown or retracted by key from either side. Bolt automatically deadlocks when fully thrown.                    | <b>E2141</b> |

### SPECIFICATIONS

**DOOR THICKNESS:** 1-5/8" to 2"  
**BACKSET:** 2-3/8", 2-3/4" SCL w/1-1/8" wide face  
**BORE:** 1-1/2" or 2-1/8" x 1"(1-1/16" for Drive-in bolt)  
**KEY BLANKS:** 35-100- 5-pin; 35-101- 6-pin  
**KEYWAYS:** P-C Standard, 6-pin, keyed to 5 pin  
 E, F Optional in most cases. **EVEREST-**  
 C123 or C145 also available.  
**J-Less Full Size Interchangeable Core-**  
 limited selection (626).  
**BD-Less SFIC- limited selection (626).**  
**FINISHES:**  
**605** (US-3) Bright Brass, clear coated  
**609** (US-5) Antique Brass, clear coated  
**613** (US-10B) Oil Rubbed Bronze  
**619** (US-15) Satin Nickel  
**626** (US-26D) Satin Chrome

### To Order, Specify:

Function: **B660P** Single Cylinder  
 Finish: **626** Satin Chrome  
 Latch: **234** 2-3/4" Backset

### Cylinder Options (Limited Selection-Please Call)

Just replace "P" with...

**J-** Less Full Size Interchangeable Core. Pictured at right. (626)  **23-030-C**  
**23-030-C123**  
**23-030-C145**  
**BD-Less SFIC-Small Format I/C (626)** **23-030-E**

## For Heavy Duty Residential & Commercial

- ANSI A156.5, 2001, Grade 2.
- 1" Throw, With Concealed Hardened Steel Roller.
- 3-year Mechanical Warranty.



20 locks per case

| No.            | Operation   |
|----------------|---|
| <b>BC160P</b>  | <b>SINGLE CYLINDER</b> -Deadbolt thrown or retracted by key from outside or by inside turn unit. Bolt automatically deadlocks when fully thrown. (ANSI E2152) |
| <b>BC162P*</b> | <b>DOUBLE CYLINDER</b> -Deadbolt thrown or retracted by key from either side. Bolt automatically deadlocks when fully thrown. (ANSI E2142)                    |
| <b>BC180</b>   | <b>DOOR BOLT</b> -Deadbolt thrown or retracted by turn unit only. No outside trim. Bolt automatically deadlocks when fully thrown. (ANSI E2192)               |



### SPECIFICATIONS

**DOOR THICKNESS:** 1-3/8" to 1-3/4"  
**BACKSET:** AL-Adjustable for 2-3/8" or 2-3/4" Sq. Corner. Some locks may be available with the 3AL-Adjustable latch for 2-3/8", 2-3/4" with Square Face/Round Face/Drive-in.  
**BORE:** 1-1/2" or 2-1/8" x 1"  
**KEY BLANKS:** 35-100- 5-pin; 35-101- 6-pin  
**KEYWAYS:** P-C Standard, 6-pin, keyed to 5 pin  
 E, F Optional in most cases. **EVEREST-**  
 C123 also available.  
**J-Less Full Size Interchangeable Core-**  
 limited selection (626).  
**BD-Less SFIC- limited selection (626).**  
**L-Less cylinder- limited selection (626)**  
**FINISHES:**  
**605** (US-3) Bright Brass, clear coated  
**609** (US-5) Antique Brass, clear coated  
**612** (US-10) Satin Bronze, clear coated  
**613** (US-10B) Oil Rubbed Bronze  
**625** (US-26) Bright Chrome  
**626** (US-26D) Satin Chrome

### To Order, Specify:

Function: **BC160P** Single Cylinder  
 Finish: **626** Satin Chrome  
 Latch: **AL** Adjustable Backset

### Cylinder Options (Limited Selection-Please Call)

Just replace "P" with...

**J-** Less Full Size Interchangeable Core. Pictured at right. (626)  **23-030-C**  
**23-030-C123**  
**23-030-C145**  
**BD-Less SFIC-Small Format I/C (626)** **23-030-E**  
**L-** Less cylinder (BC160L 626 only)

**\*Caution:** Double cylinder locks on residences and any door in any structure which is used for egress are a life safety hazard in times of emergency and their use is not recommended. Installation should be in accordance with existing codes only.

**181**<sub>v1</sub>  
**(PL-10)**

©ZIPF LOCK COMPANY

# SCHLAGE

20 locks per case



## For Residential & Commercial

- ANSI A156.5, 2001, Grade 2
- 9/16" Throw Deadlatch That Prevents "shimming" The Bolt With a Credit Card or Similar Tool.
- Trim Rings are Reinforced With Hardened Steel Inserts.
- A "hold-back" Feature Retains the Deadlatch in a Retracted Position When Desired.
- 3-year Mechanical Warranty.

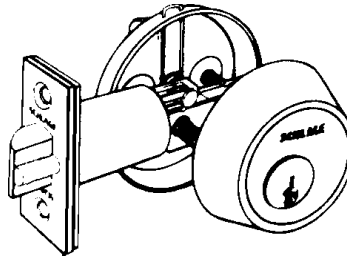

| Function                | No.            | Operation  | ANSI         |
|-------------------------|----------------|--|--------------|
| NIGHT LATCH             | <b>B250PD</b>  | Deadlocking latchbolt retracted by key from outside or by inside turn unit. Rotating turn unit and activating hold-back feature keeps latch retracted. | <b>E2122</b> |
| DBL. CYLINDER DEADLATCH | <b>B252PD*</b> | Deadlocking latchbolt retracted by key from either side. No holdback feature.  | <b>E2112</b> |

### To Order, Specify:

Function: **B250PD** *Single Cylinder*  
 Finish: **626** *Satin Chrome*  
 Latch: **234** *2-3/4" Backset*

### SPECIFICATIONS

**DOOR THICKNESS:** 1-3/8" to 1-3/4"  
**BACKSET:** 2-3/8" or 2-3/4"  
**BORE:** 1-1/2"  
**BOLT THROW:** 9/16"  
**KEY BLANK:** 35-100-C 5-pin  
**KEYWAYS:** C Standard, 5-pin  
**FINISHES:** **605** (US-3) Bright Brass, clear coated  
**626** (US-26D) Satin Chrome



20 locks per case

## For Residential & Commercial

- ANSI A156.5, 1992, Grade 2
- 1" Bolt Throw with Concealed Hardened Steel Roller to Resist Cutting or Sawing the Latchbolt.
- Reinforced Trim Ring Rotates to Protect Against Wrenching the Cylinder.
- Residential Lifetime Mechanical Warranty.
- Residential 10-year Finish Warranty.
- Residential 505-Ultima™ Lifetime Finish.

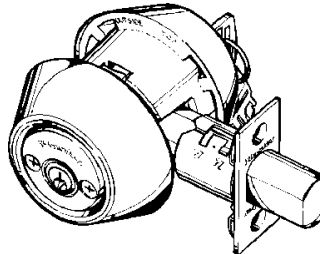

Limited supply -  
Discontinued by factory.

| Function        | No.           | Operation  | ANSI         |
|-----------------|---------------|--|--------------|
| SINGLE CYLINDER | <b>BR260</b>  | Deadbolt thrown or retracted by key from outside or by inside turn unit. Bolt automatically deadlocks when fully thrown. | <b>E2152</b> |
| DOUBLE CYLINDER | <b>BR262*</b> | Deadbolt thrown or retracted by key from either side. Bolt automatically deadlocks when fully thrown.                    | <b>E2142</b> |

### SPECIFICATIONS

**DOOR THICKNESS:** 1-3/8" to 1-3/4"  
**BACKSET:** 3AL-Adjustable latch for 2-3/8", 2-3/4" with Square Face/Round Face/Drive-in.  
**BORE:** 2-1/8" x 1"  
**KEY BLANK :** 35-100-C 5 pin  
**KEYWAYS:** C Standard, 5-pin  
**FINISHES:** **505** Bright Brass, ULTIMA™-Lifetime  
**605** (US-3) Bright Brass, clear coated  
**609** (US-5) Antique Brass, clear coated  
**625** (US-26) Bright Chrome  
**626** (US-26D) Satin Chrome

### To Order, Specify:

Function: **BR260** *Single Cylinder*  
 Finish: **605** *Bright Brass*  
 Latch: **3AL** *Triple Option Latch*

# SCHLAGE

See pages 178 for ACCENTS Series, page 177 for electronic deadbolt



20 locks per case

## For Heavy Duty Residential/Light Duty Commercial

- ANSI A156.5, 2001, Grade 2.
- 1" Throw Deadbolt with Concealed Hardened Steel Roller to Prevent Cutting or Sawing the Bolt.
- Concealed Spin Ring Rotates to Protect Against Wrenching the Cylinder.
- Solid Brass 5-pin Cylinder. Pick Resistant Spool Pins.
- Solid Steel Door Frame Reinforcer with 3" Screws Protects Against Kick-in Attack.
- Residential Lifetime Mechanical Warranty.
- Residential 10-year Finish Warranty (605/609/626).
- Residential 505-Ultima™ Lifetime Finish.
- Residential Artisan Lifetime Finish(613/619/620/625).

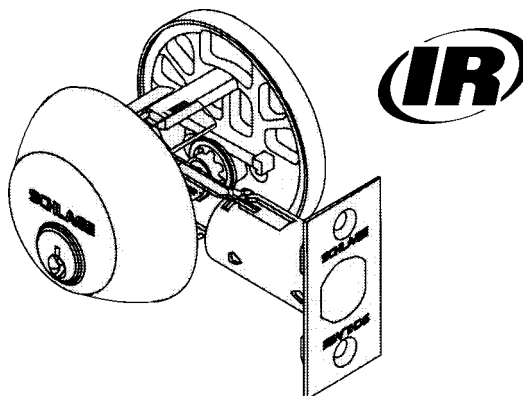

| Function        | No.           | Operation  | ANSI         |
|-----------------|---------------|--|--------------|
| SINGLE CYLINDER | <b>B360N</b>  | Deadbolt thrown or retracted by key from outside or by inside turn unit. Bolt automatically deadlocks when fully thrown. | <b>E2152</b> |
| DOUBLE CYLINDER | <b>B362N*</b> | Deadbolt thrown or retracted by key from either side. Bolt automatically deadlocks when fully thrown.                    | <b>E2142</b> |

### To Order, Specify:

Function: **B360N** *Single Cylinder*  
 Finish: **619** *Satin Nickel Plated*  
 Latch: **3AL** *Triple Option Latch*

### SPECIFICATIONS

**DOOR THICKNESS:** 1-3/8" to 1-3/4"  
**BACKSET:** Adjustable 2-3/8" to 2-3/4" with square, round corner and Drive-in faces  
**BORE:** 1-1/2" or 2-1/8" x 1"  
**KEY BLANK:** 35-100-C 5-pin  
**KEYWAYS:** C Standard, 5-pin  
**FINISHES:**  
**505** Bright Brass, ULTIMA™-Lifetime  
**605 (US-3)** Bright Brass, clear coated  
**609 (US-5)** Antique Brass, clear coated  
**613 (US-10B)** Oil Rubbed Bronze-Artisan Lifetime  
**619 (US-15)** Satin Nickel Plated-Artisan Lifetime  
**620 (US-15A)** Antique Pewter-Artisan Lifetime  
**625 (US-26)** Bright Chrome-Artisan Lifetime  
**626 (US-26D)** Satin Chrome  
**716** New Aged Bronze

\*613 is a living finish and will wear and change appearance over time

6 sets per case

## Maximum Security Combo Pack

- Keyed Alike for Double Security.
- Same Key Operates Both Deadbolt and Keyed Entry Lock.



| No.            | Operation  |
|----------------|--|
| <b>FB350NV</b> | <b>SINGLE CYLINDER</b> -Keyed alike entry lock (F51) and 1" throw deadbolt (B360N). Furnished with 4 keys. |

### To Order, Specify:

Function: **FB350NV** *Combo Pack*  
**\*\*Design:** **ACC** *Accent*  
 Finish: **505** *Bright Brass, Ultima™ Lifetime*  
 Latch: **3AL** *Triple Option Latch*  
**\*\*\*Handing:** **RH** *Right Hand*

\* Available in the following Designs:  
**ACC 505; BEL 505; FLA 505; GEO 505, 609; PLY 505.**  
**\*\*\*HANDING** required on Accent and Flair (RH or LH).

With the Triple Option Latch you have 6 latches in 1. Adjustable for 2-3/8" and 2-3/4" backsets. You can snap on the face that you need: square corner, round corner or drive-in. **Also 2 strikes:** 1 square and 1 round corner. Now you can be ready for any door.

This latch is available on BR200 Series, B300 Series, FB350 Series, FB Handles and most F locks we stock. Just specify latch (**3AL**) when ordering locks.

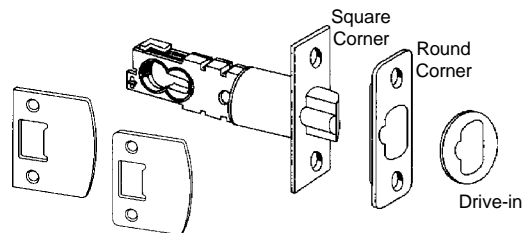

**\*Caution:** Double cylinder locks on residences and any door in any structure which is used for egress are a life safety hazard in times of emergency and their use is not recommended. Installation should be in accordance with existing codes only.

# SIMPLEX



- 3-hour UL.ULC fire rating for "A" label doors
- Vandal resistant, 5 button
- Retrofits 2-1/8" standard bore cylindrical locksets

### SPECIFICATIONS

**Lock Body:** Height 8-7/8" x Width 2-3/4" x Depth 2-9/16"  
**Backset:** 2-3/4"  
**Throw:** 1/2"  
**Bore:** 2-1/8"  
**Strike:** T-strike with strike box  
**Door Thick.:** 1-3/8" to 2-1/4"  
**Minimum Stile:** 5"  
**Handing:** Factory handed left, field reversible

Access by combination, while allowing free egress at all times by interior knob. The lockset automatically relocks each time the door closes. The lock can be inverted if the existing auxiliary lock obstructs installation.

**Combination Code:** One code per lock made of any combination of one to five numbers (pressed individually or simultaneously). **Number of Combinations:** Thousands of possible combinations.

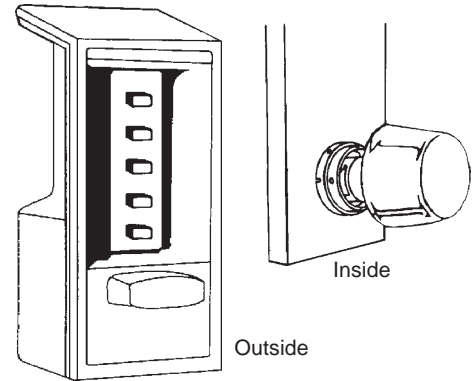

| <u>Stock No.</u> | <u>Finish</u> |
|------------------|---------------|
| SI-6204-60-41    | Gold Tone     |
| SI-6204-85-41    | Black         |
| SI-6204-86-41    | Grey          |

- Vandal resistant, 5 button

### SPECIFICATIONS

**Lock Body:** Height 8-7/8" x Width 2-3/4" x Depth 2-9/16"  
**Backset:** varies by model number  
**Throw:** varies by model number  
**Bore:** 1-3/8" x 1" (except 7106: 3/4")  
**Strike:** **7102, 7108:** Flat strike  
**7104:** curved lip strike  
**7106:** box strike for inswing door, flat or outswing doors  
**Door Thick.:** 1-3/8" to 2-1/4"  
**Minimum Stile:** 4"  
**Handing:** Field reversible

The 7100 Series lockset provides fully mechanical primary or auxiliary push-button access control by exterior combination, while allowing free egress at all times by interior thumbturn. Deadbolt models are manually relocking. Deadlocking models automatically relock each time the door closes. 7100 Series locks mount above the existing lockset, or can be used alone.

**Combination Code:** One code per lock made of any combination of one to five numbers (pressed individually or simultaneously). **Number of Combinations:** Thousands of possible combinations.

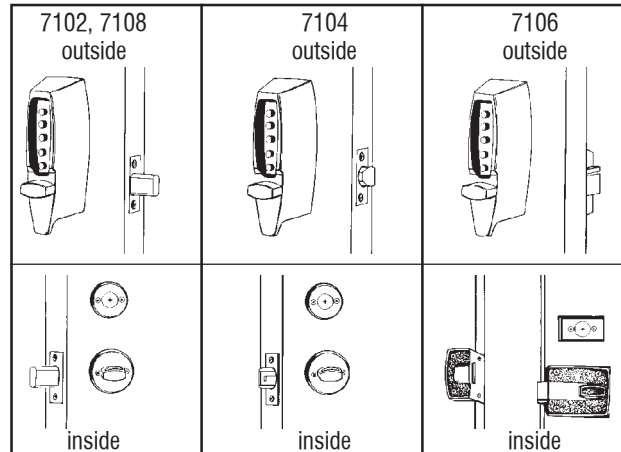

| <u>Stock No.</u>   | <u>Finish</u>        |
|--|----------------------|
| • 1" deadbolt, 2-3/4" backset, Manual relock.  |                      |
| SI-7102-03-41  | Bright Brass         |
| SI-7102-26D-41   | Satin Chrome         |
| • 1" deadbolt, 2-3/8" backset, Manual relock.  |                      |
| SI-7108-03-41  | Bright Brass         |
| • 1/2" deadlocking latch, 2-3/8" - 2-3/4", Auto relock.  |                      |
| SI-7104-03-41  | Bright Brass         |
| SI-7104-26D-41   | Satin Chrome         |
| • 5/8" deadlocking latch (surface), 2-3/8" backset, Auto relock & latch holdback. For wood doors only. |                      |
| SI-7106-19-41  | Black (Powder Paint) |
| SI-7106-26D-41   | Satin Chrome         |

**We are your source for Simplex**

*The 7000 Series is changing to the 7100 Series.*

# WEISER

## WEISER LOCK™

6 locks per case

### Powerbolt Deadbolts

- 1" projection deadbolt latch with 1/4" diameter hardened steel free-turning roller.
- Easy to Install, Easy to Program, Easy to Use.
- Requires 4 "AA" alkaline batteries (not included).
- Residential 1-Year Electrical components warranty.
- Residential Lifetime Mechanical warranty.
- Residential Lifetime Finish warranty.

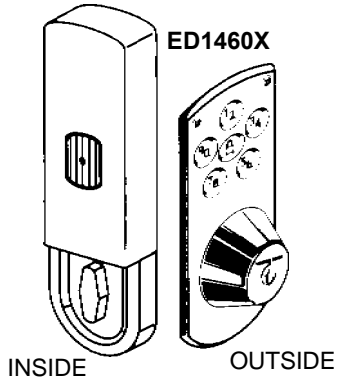

## Powerbolt

### SPECIFICATIONS

|                        |   |
|------------------------|---|
| <b>DOOR THICKNESS:</b> | 1-3/8" to 2"  |
| <b>BACKSET:</b>        | Adjustable 2-3/8" to 2-3/4"   |
| <b>BORE:</b>           | 2-1/8" x 1"   |
| <b>BOLT THROW:</b>     | 1"  |
| <b>FINISHES:</b>       | <b>US-3<sup>B</sup></b> Bright Brass<br><b>US-15</b> Satin Nickel<br><b>US-26D<sup>B</sup></b> Satin Chrome |

<sup>B</sup>Brilliance Finish is standard on exterior side of locks.-

*Other finishes available by special order.*

|           |                |                 |
|-----------|----------------|-----------------|
| Function: | <b>ED1460X</b> | Single Cylinder |
| Finish:   | <b>US-3</b>    | Bright Brass    |
| Latch:    | <b>AL</b>      | Adjustable      |

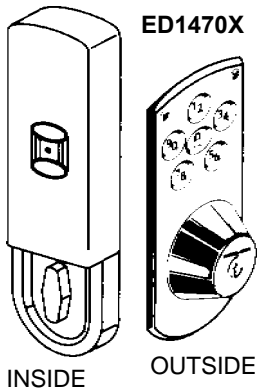

**Stock No.**  
**ED1460X**

### Operation

**Single Cylinder Deadbolt**-Deadbolt latch retracted by entering security code outside and extended by pushing lock button outside. Deadbolt latch extended and retracted by T-Turn on inside. Using key outside will retract deadbolt latch if needed.

**ED1470X**

**Same as above except** includes push button lock and unlock buttons on inside to extend or retract deadbolt.

### Electronic Keyless Entry System

- Simply enter your personalized access code for convenient, quick and carefree entry.
- You may also program a temporary second code for a neighbor, cleaning crew, etc.
- Alarm sounds after 3 consecutive incorrect codes are entered.
- Easy-one touch locking.
- Heavy duty security deadbolt and strike plate resist break-ins.
- No wiring necessary (add 4 Alkaline "AA" batteries).
- Low battery indicator.
- Fits standard preparation on new doors.
- Easily replaces existing door hardware.

***We also stock Kwikset's 907 Series Powerbolt.***

# WEISER



**D9470X:** 24 locks per case.  
**D9370X:** 12 locks per case.

*Welcome Home* SERIES®

## Heavy Duty Deadbolts

- ANSI A156.5, Grade 2 on wooden frames.
- 1" projection deadbolt latch with 1/4" diameter hardened steel free-turning roller.
- Single cylinder T-turn meets handicapped specifications.
- Residential Lifetime Mechanical warranty.
- Residential Lifetime Finish warranty.

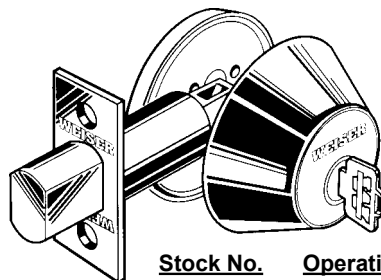

| <u>Stock No.</u> | <u>Operation</u> |
|------------------|------------------|
| <b>D9470X</b>    | Single Cylinder  |
| <b>D9370X</b>    | Double Cylinder  |

Function: **D9470X** Single Cylinder

Finish: **US-3** Bright Brass

\*Latch: **AL** Adjustable

\*Weiser Lock will be switching over to 6AL Universal latch. This latch includes drive-in latch with square corner and round corner faceplates. Most locks will be switching to round corner strikes (RCS-R2).

## SPECIFICATIONS

|                        |  |
|------------------------|--|
| <b>DOOR THICKNESS:</b> | 1-3/8" to 1-3/4"   |
| <b>BACKSET:</b>        | Adjustable 2-3/8" to 2-3/4"  |
| <b>BORE:</b>           | 1-1/2" x 1"  |
|                        | 2-1/8" x 1" acceptable if grade 2 not required.                    |
| <b>BOLT THROW:</b>     | 1"   |
| <b>STRIKE:</b>         | 10046-1  |
| <b>FINISHES:</b>       | <b>US-3<sup>B</sup></b> Bright Brass                               |
|                        | <b>US-5</b> Antique Brass, oxidized, hand relieved and highlighted |
|                        | <b>US-11P</b> Venetian Bronze™                                     |
|                        | <b>US-12</b> Tuscan Copper™  |
|                        | <b>US-15</b> Satin Nickel  |
|                        | <b>US-26D<sup>B</sup></b> Satin Chrome                             |

<sup>B</sup>Brilliance Finish is standard on exterior side of locks.



**DC9470L:** 24 locks per case.  
**DC9370L:** 12 locks per case.

## Standard Duty Deadbolts

- 1" projection deadbolt latch with 1/4" diameter hardened steel free-turning roller.
- Single cylinder T-turn meets handicapped specifications.
- Residential 25-Year Mechanical Warranty.
- Residential 10-Year Finish Warranty.

*elements* SERIES™

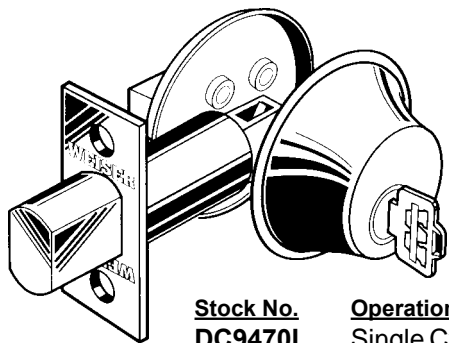

| <u>Stock No.</u> | <u>Operation</u> |
|------------------|------------------|
| <b>DC9470L</b>   | Single Cylinder  |
| <b>DC9370L</b>   | Double Cylinder  |

## SPECIFICATIONS

|                        |  |
|------------------------|--|
| <b>DOOR THICKNESS:</b> | 1-3/8" to 1-3/4"   |
| <b>BACKSET:</b>        | Adjustable 2-3/8" to 2-3/4"  |
| <b>BORE:</b>           | 1-1/2" x 1"  |
| <b>BOLT THROW:</b>     | 1"   |
| <b>STRIKE:</b>         | 5051   |
| <b>FINISHES:</b>       | <b>US-3</b> Bright Brass   |
|                        | <b>US-5</b> Antique Brass, oxidized, hand relieved and highlighted |
|                        | <b>US-15</b> Satin Nickel  |
|                        | <b>US-26D</b> Satin Chrome   |

Function: **DC9470L** Single Cylinder

Finish: **US-3** Bright Brass

\*Latch: **AL** Adjustable

\*Weiser Lock will be switching over to 6AL Universal latch. This latch includes drive-in latch with square corner and round corner faceplates. Most locks will be switching to round corner strikes (RCS-R3).

©ZIPF LOCK COMPANY

# WEISER



24 locks per case

## Gate Lock with Deadlocking Latch

- Residential Lifetime Mechanical warranty.
- Residential Lifetime Finish warranty.

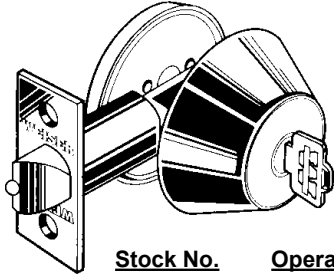

**Stock No.**  
**D840X**

**Operation**  
Single Cylinder

### SPECIFICATIONS

**DOOR THICKNESS:** 1-1/2" to 1-7/8"  
**BACKSET:** Adjustable 2-3/8" to 2-3/4"  
**BORE:** 2-1/8" x 1"  
**BOLT THROW:** 1/2"  
**FINISHES:** **US-3** Bright Brass

**Function:** **D840X** Single Cylinder  
**Finish:** **US-3** Bright Brass  
**Latch:** **AL** Adjustable

## Welcome Home SERIES®

24 locks per case

The Indicator Deadbolt has a thumbturn on the inside and displays "VACANT" on a green panel when open and "OCCUPIED" on a red panel when locked.

- Lifetime Mechanical warranty.

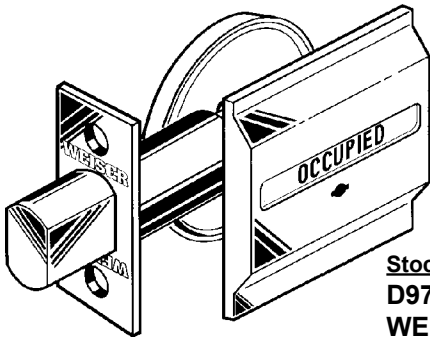

**Stock No.**  
**D9770I**  
**WE-9159**

**Operation**  
Indicator Deadbolt  
Emergency Key



### SPECIFICATIONS

**DOOR THICKNESS:** 1-3/8" to 1-3/4"  
**BACKSET:** Adjustable 2-3/8" to 2-3/4"  
**BORE:** 1-1/2" x 1"  
**BOLT THROW:** 1"  
**FINISHES:** **US-3** Bright Brass  
**US-26D** Satin Chrome

**Function:** **D9770I** Indicator Deadbolt  
**Finish:** **US-3** Bright Brass  
**Latch:** **AL** Adjustable

## Welcome Home SERIES®

24 locks per case

The Connecting Door deadbolt has a blank plate on the exterior of door. Deadbolt operated by thumbturn on interior of door.

- Residential Lifetime Mechanical warranty.

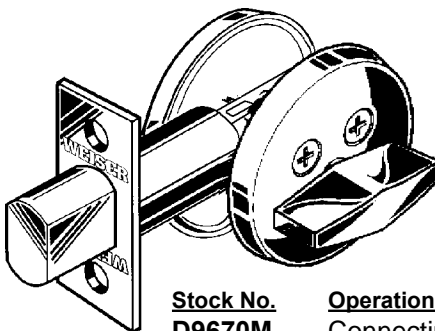

*Discontinued. Call for closeout prices.*

**Stock No.**  
**D9670M**

**Operation**  
Connecting Door Deadbolt

### SPECIFICATIONS

**DOOR THICKNESS:** 1-3/8" to 1-3/4"  
**BACKSET:** Adjustable 2-3/8" to 2-3/4"  
**BORE:** 1-1/2" x 1"  
**BOLT THROW:** 1"  
**FINISHES:** **US-3** Bright Brass  
**US-26D** Satin Chrome

**Function:** **D9670M** Connecting Door  
**Finish:** **US-3** Bright Brass  
**Latch:** **AL** Adjustable