

DOOR & CYLINDER GUARDS

LATCH PROTECTORS

The INTERLOCK for inswinging doors

<u>Stock No.</u>	<u>Size</u>	<u>Finish</u>
DJ-ILP206 SL	6"	Silver Coated
DJ-ILP206 DU	6"	Duro Coated
DJ-ILP206 BP	6"	Brass Plated
DJ-ILP212 SL	12"	Silver Coated
DJ-ILP212 DU	12"	Duro Coated
DJ-ILP212 BP	12"	Brass Plated

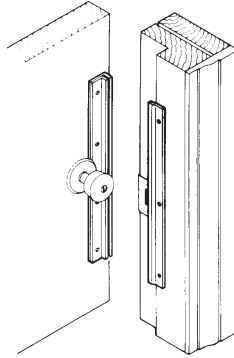

DON-JO

- 6" version for use with key-in-knob and deadbolt locks.
- 12" version for use with mortise locks, Simplex 1000 series, Alarm Lock DL-2500, DL-2700 & DL-3000, Card Access Systems, etc.
- 14 ga. (.075) Steel.

For Aluminum Entrance Doors

<u>Stock No.</u>	<u>Finish</u>
DJ-LP307 DU	Duro Coated
DJ-LP307 SL	Silver Coated

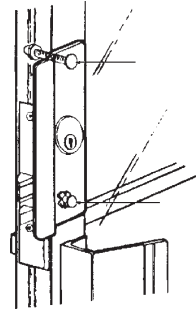

- Reversible.
- Fits over cylinder, lock removal NOT required.
- Hand carriage bolt and rivet supplied.
- No specific tools required.
- 3/8" offset.
- 2-5/8" x 7" x 1/8".
- 12 ga. (.104) Steel.

For Aluminum Entrance Doors - solves pull handle interference

<u>Stock No.</u>	<u>Finish</u>
DJ-GLP307 DU	Duro Coated

Specify Hand: LHR or RHR
(LHR shown in picture)

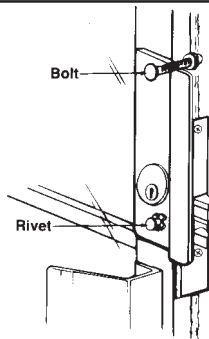

- **Handed: LHR or RHR.**
- Fits over cylinder, lock removal NOT required.
- Hand carriage bolt and rivet supplied.
- No specific tools required.
- 3/8" offset.
- 2-5/8" x 7" x 1/8".
- 12 ga. (.104) Steel.
- Center of cylinder hole is 2-1/2" from end of plate.

For Center Hung Outswinging Aluminum Doors

<u>Stock No.</u>	<u>Finish</u>	<u>Offset</u>
DJ-OLP2650DU	Duro Coated	1-1/8"
DJ-OLP2650SL	Silver Coated	1-1/8"
DJ-OLP2651DU	Duro Coated	1-3/8"
DJ-OLP2651SL	Silver Coated	1-3/8"

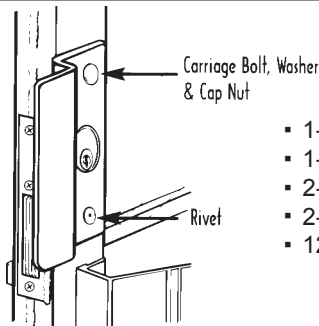

- 1-1/8" offset (OLP-2650).
- 1-3/8" offset (OLP-2651).
- 2-5/8" x 6-1/2" x 1/8" (OLP-2650).
- 2-5/8" x 6-1/2" x 3/8" (OLP-2651).
- 12 ga. (.104) Steel.

For Outswinging Doors - completely covers the strike plate

<u>Stock No.</u>	<u>Finish</u>
DJ-MLP111 630	Stainless Steel
DJ-MLP211 BP	Brass Plated
DJ-MLP211 DU	Duro Coated
DJ-MLP211 SL	Silver Coated

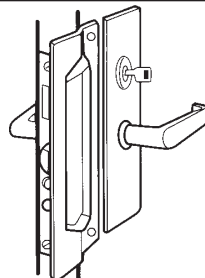

- Furnished with carriage bolts, washers & acorn nut for safety and strength.
- 3" x 11".
- 12 ga. (.104) Steel

©ZIPF LOCK COMPANY

DOOR & CYLINDER GUARDS

LATCH PROTECTORS

DON-JO

For Outswinging Doors - completely covers the strike plate

<u>Stock No.</u>	<u>Finish</u>
DJ-LP111 630	Stainless Steel
DJ-LP211 BP	Brass Plated
*DJ-9211 BP	Brass Plated
DJ-LP211 DU	Duro Coated
*DJ-9211 DU	Duro Coated
DJ-LP211 PC	Prime Coated
*DJ-9211 PC	Prime Coated
DJ-LP211 SL	Silver Coated

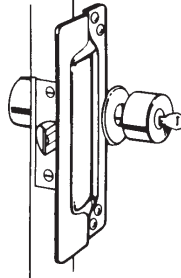

- Furnished with carriage bolts, washers & acorn cap nuts.
- 3" x 11"
- Fits 2-3/4" and 2-3/8" backsets.
- 12 ga. (.104) Steel.

***SAVE MONEY: DJ-9211 are poly-bagged and sold in multiples of 10.**

Pin Latch Protector for Outswinging Doors

<u>Stock No.</u>	<u>Finish</u>
DJ-PLP111 630	Stainless Steel
DJ-PLP211 BP	Brass Plated
DJ-PLP211 DU	Duro Coated
DJ-PLP211 SL	Silver Coated
DJ-PLP211 626	Satin Chrome



- Solid steel pin prevents spreading of door from frame.
- Pin is welded on back leaving no visible point of attack from outside.
- Extra Large cut out accepts **up to 3-1/2" rose.**
- Fits 2-3/4" and 2-3/8" backset.
- 3" x 11".
- 12 ga. (.104) Steel

Pin Latch Protector for Outswinging Doors

<u>Stock No.</u>	<u>Finish</u>
DJ-PMLP111 630	Stainless Steel
DJ-PMLP211 BP	Brass Plated
DJ-PMLP211 DU	Duro Coated
DJ-PMLP211 SL	Silver Coated

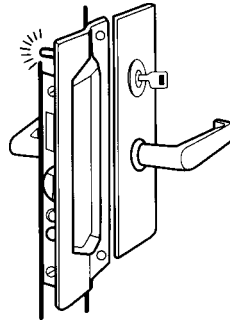

- Solid steel pin prevents spreading of door from frame.
- Pin is welded on back leaving no visible point of attack from outside.
- Fits 2-3/4" and 2-3/8" backset.
- 3" x 11".
- 12 ga. (.104) Steel

For Outswinging Doors

<u>Stock No.</u>	<u>Finish</u>
DJ-LP107 630	Stainless Steel
DJ-LP207 BP	Brass Plated
DJ-LP207 SL	Silver Coated
DJ-LP207 DU	Duro Coated



- Furnished with carriage bolts, washers & acorn cap nuts.
- 2-3/4" x 7"
- 12 ga. (.104) Steel

Commercial Type For Outswinging Doors

<u>Stock No.</u>	<u>Finish</u>	<u>Dimensions</u>
DJ-CLP106 630	Stainless Steel	2-1/8" x 6"
DJ-CLP110 630	Stainless Steel	2-1/8" x 10"

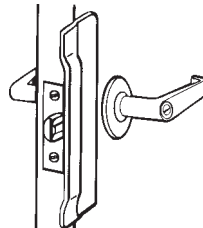

- 6" for key-in-knobs.
- 10" for mortise locks.
- Architectural design.
- Concealed welded studs with fasteners.
- 12 ga. (.104) Steel

©ZIPF LOCK COMPANY

DOOR & CYLINDER GUARDS

LATCH PROTECTORS

DON-JO

Narrow Commercial Type For Outswinging Doors

<u>Stock No.</u>	<u>Size</u>	<u>Finish</u>
DJ-NLP106 630	6"	Stainless Steel
DJ-NLP206 DU	6"	Duro Coated
DJ-NLP206 PC	6"	Prime Coated
DJ-NLP206 SL	6"	Silver Coated
DJ-NLP110 630	10"	Stainless Steel
DJ-NLP210 DU	10"	Duro Coated
DJ-NLP210 PC	10"	Prime Coated
DJ-NLP210 SL	10"	Silver Coated



- 6" for key-in-knob.
- 10" for mortise locks.
- Narrow type for outswinging doors.
- NLP106: 1-1/2" x 6"
- NLP110: 1-1/2" x 10"
- NLP206: 1-1/2" x 6"
- NLP210: 1-1/2" x 10"
- 12 ga. (.104) Steel.

For Key-In-Lever with up to 3-3/4" escutcheon

<u>Stock No.</u>	<u>Finish</u>
DJ-BLP107 630	Stainless Steel
DJ-BLP207 BP	Steel Brass Plated
DJ-BLP207 DU	Duro Coated
DJ-BLP207 SL	Silver Coated

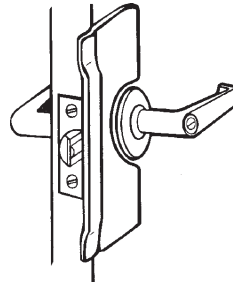

- Works with up to 3-3/4" rose.
- Fits most heavy duty key-in-lever locks.
- Concealed welded studs and fasteners.
- 3-1/4" x 7".
- 12 ga. (.104) Steel.

For Electronic Locks

<u>Stock No.</u>	<u>Finish</u>
DJ-KLP110 LH 630	Stainless Steel
DJ-KLP110 RH 630	Stainless Steel

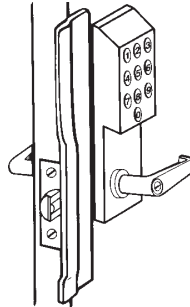

- Works with ILCO 1000, 4000 locks.
- Alarm Lock Trilogy locks.
- Mas-Hamilton Power Levers.
- Schlage Cobra locks.
- 1-1/2" x 10".
- 12 ga. (.104) Steel.

Angle Type for Outswinging Doors

<u>Stock No.</u>	<u>Size</u>	<u>Finish</u>
DJ-ALP206 BC	6"	Brass Coated
DJ-ALP206 DU	6"	Duro Coated
DJ-ALP206 SL	6"	Silver Coated
DJ-ALP210 BC	10"	Brass Coated
DJ-ALP210 DU	10"	Duro Coated
DJ-ALP210 SL	10"	Silver Coated

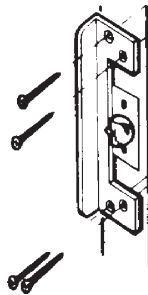

- 6" for key-in-knob.
- 10" for mortise locks.
- 1-1/2" sheet metal screws for wood or metal.
- 10 ga. (.134) Steel

For use with Electric Strikes

<u>Stock No.</u>	<u>Finish</u>
DJ-ELP208 DU	Duro Coated
DJ-ELP208 SL	Silver Coated
DJ-ELP208P DU*	Duro Coated
DJ-ELP208P SL*	Silver Coated

*Without cylinder hole.

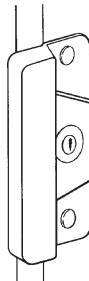

- Available with or without cylinder hole.
- Designed to fit most electric strikes.
- Completely encases the keeper for maximum protection.
- 3-1/2" x 8".
- 12 ga. (.104) Steel.

©ZIPF LOCK COMPANY

DOOR & CYLINDER GUARDS

LATCH PROTECTORS

DON-JO

Fits Folger Adams Electric Strike - for outswinging doors.

Stock No.

DJ-FLP211 SL

Finish

Silver Coated

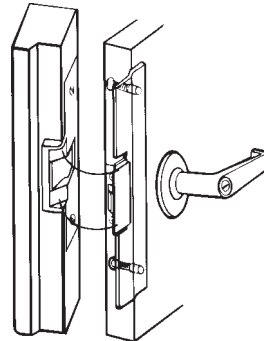

- Works with Folger Adams 310 & 710.
- 1-3/4" x 11-1/4".
- 12 ga. (.104) Steel.

Short Type for Outswinging Doors

Stock No.

DJ-SLP206 BP

Finish

Brass Plated

DJ-SLP206 SL

Silver Coated

DJ-SLP206 DU

Duro Coated

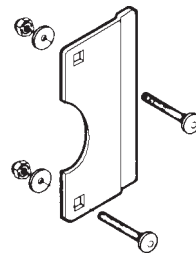

- Furnished with carriage bolts, washers & acorn cap nuts for safety & strength.
- May be used on hollow metal door/frame using ANSI strike.
- Works with up to 3-3/4" rose.
- 2-1/2" x 6"
- 12 ga. (.104) Steel

Slimline for Outswinging Doors

Stock No.

DJ-LP2878 DU

Finish

Duro Coated

DJ-LP2878 PC

Prime Coated

DJ-LP2878 SL

Silver Coated



- Fasteners Included.
- Sleek Appearance.
- 1-1/2" x 8-7/8" x 5/16".
- 5/16" thick (.3125) Steel.

Fits Adams Rite Latch Lock for outswinging doors

Stock No.

DJ-LP312 DU

Finish

Duro Coated

DJ-LP312 SL

Silver Plated

DJ-LP312P DU*

Duro Coated

DJ-LP312P SL*

Silver Coated

* No Center Hole

DJ-LP312P supplied without 1-7/16" hole. Allows installer to drill hole for custom applications.

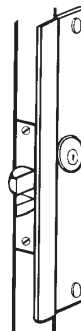

- Reversible.
- 1/4" Offset.
- 1-7/16" Hole (also available w/o hole).
- 1-1/8" Backset.
- 2-5/8" X 12" X 1/8".
- 12 ga. (.104) Steel.

Your warehouse around the corner!!!

DOOR & CYLINDER GUARDS

ALUMINUM DOOR SECURITY



STYLE GUARD—K-9/K-21

Made of 12 gauge steel, Style Guard reinforces or repairs aluminum-style doors. 8" long. KD-K-9 for standard 4" jambs and KD-K-21 for 4-1/2" jambs. Designed with a "knock-out" to accommodate either the W&F or the Adams Rite bolt. Baked on enamel-type finish matches nicely for a professional looking job.

Stock No.	Length	Finish
KD-K-9A 626	4"	Aluminum Finish
KD-K-9B 613	4"	Duronotic Finish
KD-K-21A 626	4-1/2"	Aluminum Finish
KD-K-21B 613	4-1/2"	Duronotic Finish

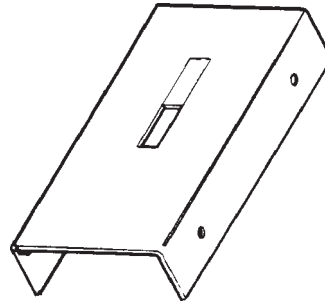

DOUBLE DOOR STYLE GUARD—K-15

Finally a better way to secure a set of double aluminum doors!! 12 gauge steel increases security and can repair doors that have already been attacked. 7-3/4" long, for 1-3/4" doors. Designed with knock out feature to make a W&F into an Adams Rite

Stock No.	Finish
KD-K-15A 626	Aluminum Finish
KD-K-15B 613	Duronotic Finish

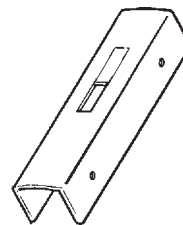

OFFSET STYLE GUARD—K-20

To complete our style guard line we finally have a guard for the offset aluminum door or doors that swing one way with jamb stops. 7" long. This non-handed guard is easy to install and comes with pop rivets and carriage bolts.

Stock No.	Finish
KD-K-20A 626	Aluminum Finish
KD-K-20B 613	Duronotic Finish

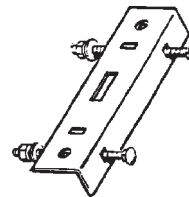

CYLINDER GUARD RING—K-24

Hardened steel, free spinning, tapered cone shaped cylinder guard. Works with both 5 and 6 pin cylinders. Kit includes 6 of each: ring, stainless steel wave washer and spacing collar.

Stock No.	Finish
KD-K-24A 626	Aluminum Finish
KD-K-24B 613	Duronotic Finish

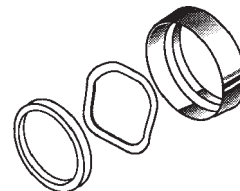

PROTECT-A-LOK—K-12

Finally a product designed to protect locks from impact damage. The Keedex KD-K-12 Protect-A-Lok, made from U.L. approved Lexan plastic, is virtually indestructible by impact. Designed for use in areas where locks may have a chance of getting hit by carts, forklifts or moving vehicles. Can be used with levers, knobs or panic hardware with any size backset. Installs in minutes. Guaranteed for 5 years.

Stock No.	Finish
KD-K-12	Cream Finish
KD-K-12D	Duronotic Finish

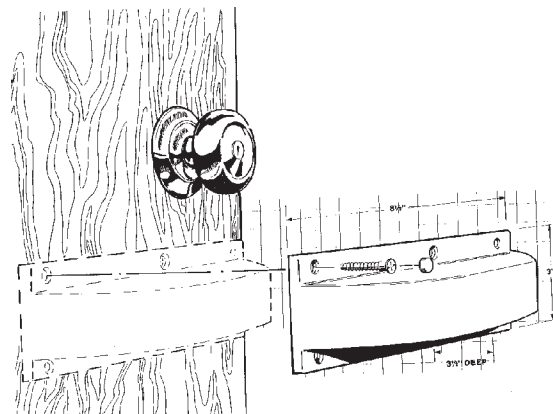

Ideal for Super Markets, Warehouses, Hotels, Hospitals, Restaurants and more.

©ZIPF LOCK COMPANY

DOOR & CYLINDER GUARDS

HEAVY DUTY GUARD PLATE



VDG-10

The VDG-10 is the strongest and most popular guard plate. It is 14" long and is made from 2 pieces of 16 gauge cold rolled steel, welded together with a baked Matte Bronze finish.

This guard plate offers maximum resistance to prying and forcing. It mounts onto your door with 2 carriage bolts going through the door and anchored with a nut and cap nut on the inside. Four wood screws go into the edge of the door. Guard plates come complete with all necessary hardware and illustrated instructions.

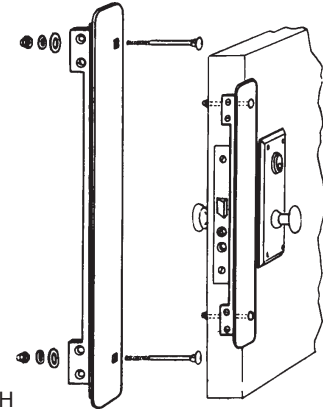

1-3/4"W x 14"H

PROTECT AGAINST
BREAK-INS!!

LATCH-GARD®

Finishes:
BB- Bright Brass
D- Duranodic
Z- Zinc Plated

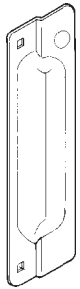

3" x 11"
LG-100



3" x 11"
LG-110



1-1/2" x 6"
LG-120



1-1/2" x 10"
LG-130



2-1/2" x 10"
LG-140



2-5/8" x 6"
LG-150



12" x 2-5/8"
Fits Adams Rite
LG-160

1-7/8" x 12"

LG-170
3/8" offset

LG-171
1/2" offset

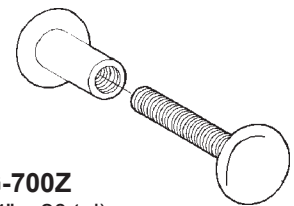

LG-700Z
(1/4" x 20 tpi)
with screw

LG-710Z
(5/16" x 18 tpi)
with screw

TO ORDER: Specify Guard No. and Finish.

LG-100 + BB = LG-100-BB

DOOR & CYLINDER GUARDS



LORI

"THE BLOCKER"

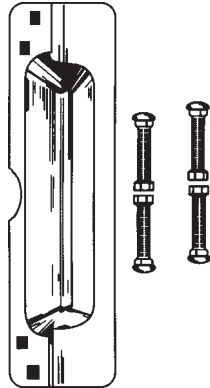

Discontinued.
Call for closeout prices

"THE SUPER BLOCKER" FOR ALUMINUM DOORS

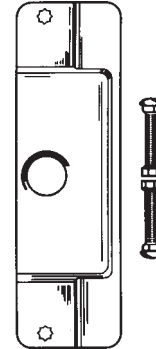

Application: The Blocker® discourages forced entry attempts on outswinging doors. 3" x 10-7/8"

Stock No. **Finish**
\$LOR-1100 DU Duranodic

Application: The Super Blocker® is designed for narrow style aluminum doors. Reversible. Complete with 2 sex nuts. 3-1/2" x 12"

Stock No. **Finish**
\$LOR-1120 AL Aluminum

CAL-ROYAL

CR-LPG2
Latch Guard
Finishes:
ALUM, DURO,
GOLD, USP

2-7/8" x 11"



Stock No. **Finishes**
MAG-8840-B Brass
MAG-8840-C Chrome

Latch Guard 7", for In-Opening doors. All backsets, Deadbolts and Key-in-knobs locks. Reinforces door and frame, prevents spreading of frame, hardened conealed screws. 14GA. U.S. Pat. 5,395,145

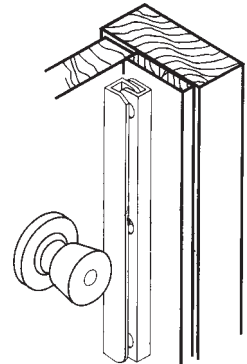

Stock No. **Finishes**
MAG-8843-B Brass
MAG-8843-C Chrome

Latch Guard 12", for In-Opening doors. All backsets, Deadbolts and Key-in-knobs locks. Double locks, Mortise Locks & Access control locks. Reinforces door and frame, prevents spreading of frame, hardened conealed screws. 14GA. U.S. Pat. 5,395,145

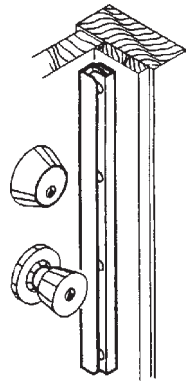

Stock No. **Finishes**
MAG-8845-B Brass
MAG-8845-C Chrome

Latch Guard 6", for Out-Opening doors. All backsets, Deadbolts and Key-in-knobs locks. Protects latch or bolt, heavy gauge steel. Accepts up to 3-1/2" rose, 7/16" offset. 12 GA.

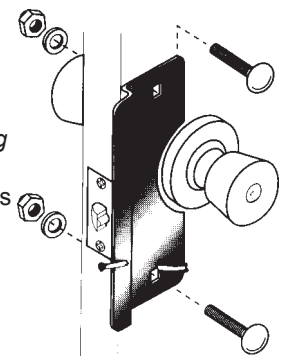

DOOR & CYLINDER GUARDS



Stock No. **Finishes**
MAG-8848-B Brass
MAG-8848-C Chrome

Latch Guard Heavy Duty 7", for Out-Opening doors. All backsets, Deadbolts and Key-in-knobs locks. Protects latch or bolt. Conceals lip if existing strike. Accepts up to 3-1/2" rose. 12 GA.

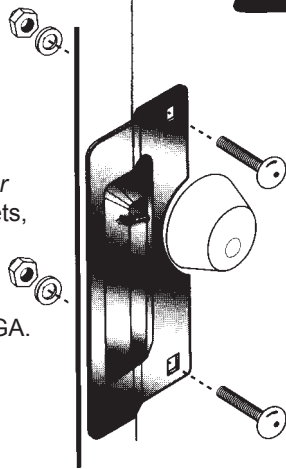

Stock No. **Finishes**
MAG-8850-B Brass
MAG-8850-C Chrome

Latch Guard Universal 11-3/4", for Out-Opening doors with 1" x 8-3/4" Cutout. All backsets, single locks, double locks up to 6" on center, combination locks, mortise locks & access control locks. Protects latch and bolt, conceals lip of existing strike. Reinforced mounting area. 12GA. with anti-spread pin. U.S. Pat. 5,415,020.

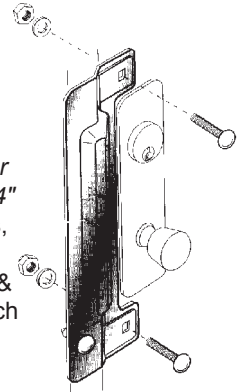

Stock No. **Finishes**
MAG-8852-AL Aluminum
MAG-8852-DU Duronodic

Latch Guard 6-1/2", for Out-Opening doors. Narrow stile, store front doors with cylinder guard and drive rivet, 3/16" offset with 1/2" clearance under channel. 12GA.

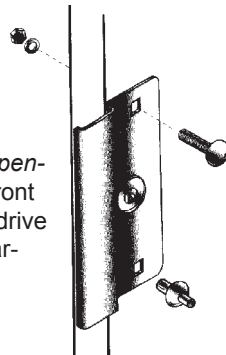

Stock No. **Finishes**
MAG-8854-AL Aluminum
MAG-8854-DU Duronodic

Latch Guard 12", Removable (for flush doors). With anti-spread pins for single or double acting doors with cylinder guard. 12GA. U.S. Pat. 5,547,239.

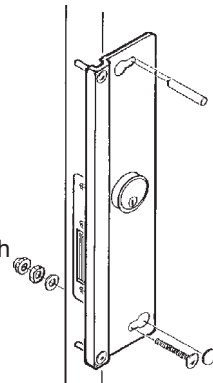

Stock No. **Finishes**
MAG-8855-AL Aluminum
MAG-8855-DU Duronodic

Latch Guard 12", Removable (for center hung 4" frame). With anti-spread pins for center hung doors, 1-1/8" offset for 4" frame with cylinder guard, for single or double acting. 12GA. U.S. Pat. 5,547,239.

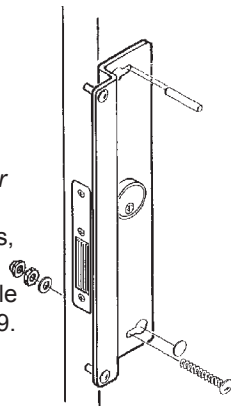

MISCELLANEOUS

DOOR BOLTS

Decorative Surface Bolts

- Features attractive 1/2" half-round rods and well-proportioned guides.
- Semi-concealed guides assure smooth operation and are positioned under the rod to eliminate marring the surface of the bolt.
- Stainless steel tension spring prevents rod disengagement from guide and provides tension to hold bolt in desired position.
- Decorative **3/4" diameter knob** designed to facilitate bolt operation.
- Made from burnished steel.
- Available in 6" length.
- Packed with both Universal and Angle Strikes.
- Meets design requirements of ANSI/BHMA A156.16.
- Dimensions: Throw: 1"; Projection: 15/16"; Half Round Rod: 1/2"; Overall Width: 1-3/8".

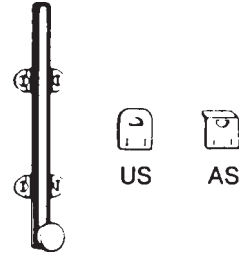

Stock No. (Specify Finish & Length)
IV-43F3 6" 6" length - Steel
Finishes: 3

Dutch Door Bolts

- Practical, rugged, attractive bolt for application on dutch doors as well as other areas.
- Chamfered rod end draws the two leaves of door tightly together.
- Sufficient tolerance provided in strike opening to allow for misalignment of door leaves and also prevents binding of bolt.
- Decorative 1" diameter knob designed to facilitate bolt operation.
- Made from solid brass.
- Packed with Standard Strike.
- Dimensions: Throw: 5/8"; Projection: 1-1/8"; Half Round Rod: 5/8"; Overall Width: 1-5/8"; Rod Length: 4-1/4"; Overall Length, including knob: 4-3/8"

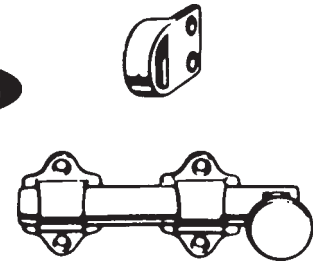

Stock No. (Specify Finish & Length)
IV-054MB 6" length - Steel
Finishes: 3, 26D

Surface Bolt

- Surface Bolt has 1-3/16" throw for maximum security.
- Strong tension springs prevent creep.
- Ideal for all types of doors.
- Available 12" length. (8", 18" and 24" by special order)
- Unit packed with standard screws for added security.
- Unit packed with both a universal top strike (T) and a mortise bottom strike (B).
- Constructed of heavy duty steel.
- 8" and 12" Bolts are UL listed up to 3 hours when used on the inactive door of a pair up to 10' in height.
- Meets ANSI/BHMA A156.16 L84161
- Dimensions: Bar: 3/4" Wide x 1/4" Thick; Overall Width: 2-1/32"; Overall Projection: 1-5/16"
 Top Strike: 1-1/2" x 1-1/2" Angle, 3/16" Thick; Bottom Strike: 3-1/2" Long x 1-5/8" Wide x 1/8" Thick.

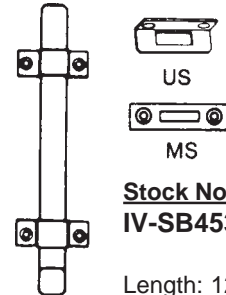

Stock No.
IV-SB453-12-TB 26D

Length: 12"
Finishes: 26D

Master Lock

DUAL FUNCTION DOOR SECURITY BAR

Adjusts to fit most Sliding and Hinged doors

Non-marring yoke (removable for sliding doors)
 Designed to fit most doors, simple push button adjustment.
 High strength steel tube. 20-gauge.
 Portable. Collapsible, to fit most suitcases and garment bags.
 Pivoting ball joint for full contact on floor.
 Padded foot provides sure grip on most floors.
 Lifetime Guarantee.

Stock No.
265D (White)

For Sliding Doors

For Hinged Doors

© ZIPP LOCK COMPANY

DOOR CHAINS

CAL-ROYAL

CR-DG22

US3 Solid Brass
 Chain Door Guard
 6-3/4" Chain



DOOR GUARDS

CAL-ROYAL

CR-BBDHG88

US3, 26D
 Zinc Diecast Swing Bar
 Door Guard with
 ball bearing
Limited supply of US-5.
Call for closeout price.

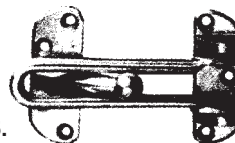

FLIP LOCK MAG-8705

For in-opening doors. Left or right hand.
 Heavy gauge steel.



MISCELLANEOUS

DOOR GUARDS

IVES

- Solid Bar Door Guard is for use on doors that are flush with frames.
- The solid bar, interlocking with the ball on the strike plate, permits the door to be slightly opened to allow viewing.
- The hinged bar allows the door guard to be positioned 180° away from the door when not in use.
- Edge guard, furnished with cast brass door guards, minimizes the chance for marring the door or frame.
- Strike plate is designed to prevent the solid bar from marring the inside of the door when in use.
- Easy installation.
- Meets ANSI/BHMA A156.16.
- Made from cast brass or cast aluminum.
- Packed with sheet metal screws.
- Dimensions of Cast Brass Door Guard: Strike Plate: 2-5/8" x 1-1/32"; Holder: 1-3/4" x 1-1/16"; Arm Length: 4-3/4"; Edge Guard: 1-1/8" x 1-1/32"
- Dimensions of Cast Aluminum Door Guard: Strike Plate: 2-1/2" x 7/8"; Holder: 2-1/2" x 15/16"; Arm Length: 3-13/16".

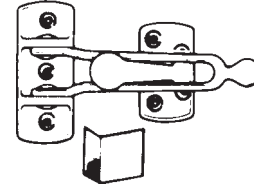

Stock No. (Specify Finish)

IV-482A Cast Aluminum

Finishes: 3, 26D

IV-482B Cast Brass

Finishes: 3, 5, 10B, 15, 26, 26D

DON-JO

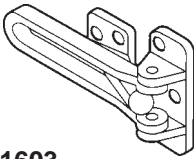

DJ-1603

Finishes: 605, 625, 626
Material: Aluminum. Edge protector included (1" x 1" x 1/2").
ANSI L33042.

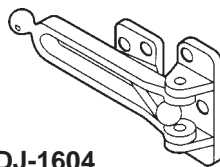

DJ-1604

Finishes: 605, 625, 626
Material: Brass. ANSI L13042.

DOOR SILENCERS

CAL-ROYAL

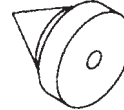

CR-DSM21

Rubber Door Silencer.
1/2" Dia. 11/16"
Length. For metal frames
(Sold in bags of 100)



CR-DSW85

Rubber Door Silencer.
3/8" x 3/4" Base, 3/4" length. For wood frames
(Sold in bags of 100)

DOOR VIEWERS

CAL-ROYAL



160° Door Viewer
1/2" Bore

CR-DV90 (plastic lens)

US3, 10B, 15, 26

CR-ULDV160* (glass lens)

US3, 26

*UL Listed



Door Viewer
9/16" Bore

CR-DV180 180° (plastic lens)

US3, 5, 10B, 15, 26

CR-ULDV200* 200° (glass lens)

US3, 10A, 26

*UL Listed

IVES

One-Way Wide Angle Viewer

- 190° Angle of View.
- Lens projects 1/4" from face of door.
- 4 optical glass lenses.
- For doors 1-3/8" to 2-1/8" thick.
- Solid brass body and barrel.
- Simple installation — only a 9/16" hole required.
- Conforms to ANSI/BHMA A156.16 L23172 and L23222.
- Suggested installation height: 60" from floor.

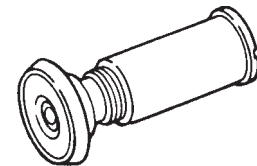

Stock No. (Specify Finish)

IV-698B

Finishes: 3, 26D

One-Way Viewer

- 120° Angle of View.
- For doors 1-3/8" to 2-1/16" thick.
- Secure, tamper-resistant.
- Solid brass body; glass lens.
- Simple installation — only a 1/2" hole required.
- Suggested installation height: 60" from floor.
- Conforms to ANSI/BHMA A156.16 L23173.

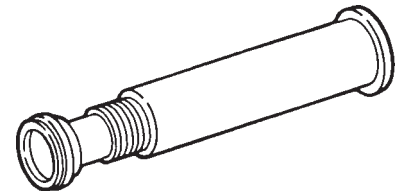

Stock No. (Specify Finish)

IV-700B

Finishes: 4, 26D

See page 427 for Cal Royal, Don Jo, Ives finish descriptions.