

KEY CABINETS

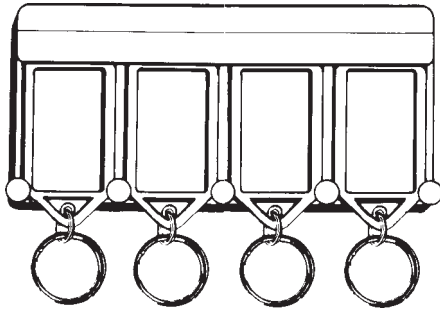

TAG RACKS



LKC-60540

This 4 key Tag (color coded) Rack comes with pressure sensitive pads for easy mounting to any surface. Size: 5" X 2-1/2" X 1/2".

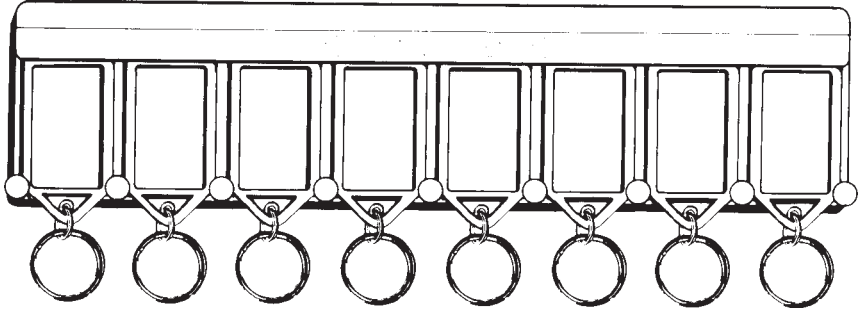

LKC-60580

This 8 Key Tag (color coded) Rack comes with two screws for easy mounting. It can also be mounted with pressure sensitive tape. Size: 10" X 2-1/2" X 1/2".



DIGITAL KEKABS®

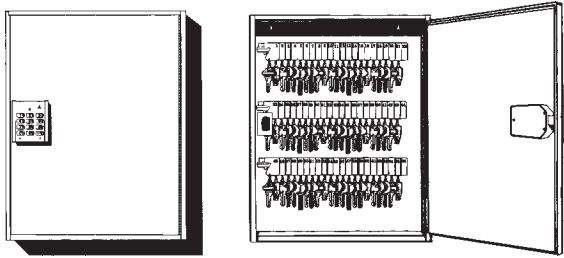

<u>Stock No.</u>	<u>Capacity</u>	<u>Dimensions</u>
KEKAB-DL65	65 keys	17" x 13" x 3-1/4"

The new Digital KeKabs® have all the same features of our regular KeKab®, but are opened by a user friendly keypad, rather than a key.

The Digital KeKab's® intelligent features include 2 levels of access (User and Manager), with an overriding Owner code, instant re-programming, usage indicator, and automatic lock-out. These units are battery operated and require no wiring or central processors. The locks run on two 9-volt alkaline batteries. A low battery indicator warns when batteries are low, and special jumper ports allow access of external power in the event of battery failure. With its all metal construction, the Digital KeKabs® are built to last.

KEYABLE KEKABS®

Uses Mortise Cylinder

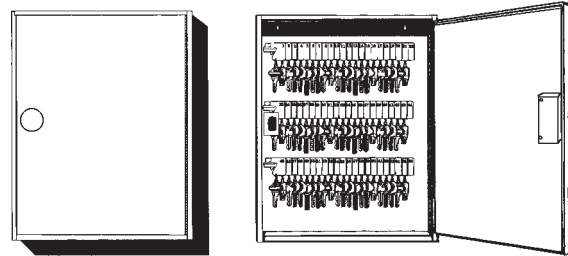

<u>Stock No.</u>	<u>Capacity</u>	<u>Dimensions</u>
KEKAB-KK95X	95 keys	20" x 16-1/2" x 5"

X-Cabinet is expandable to 265 keys.

HPC's Keyable KeKabs eliminate the problem of how to control the key to the key cabinet. This HPC exclusive line of cabinets allows you to add your own mortise cylinder, and key into the existing master key systems. The Keyable KeKabs are equipped with a heavy-duty lock assembly and are designed to use standard 1" mortise cylinders with Adams Rite cam. Longer cylinders can be accommodated using spacer rings. The mortise cylinder, keys, and spacer rings are not supplied with these KeKabs and must be ordered separately. Add convenience and security to the storage of your keys with the Keyable KeKab®.

EXPANSION LEAVES-When your key control needs grow, so can your system. Leaves are easy to install and come with all necessary hardware, numbered tags (to increase capacity number) and control chart.

<u>Stock No.</u>	<u>For KeKab:</u>	<u>Increase From</u>
KEKAB-DA	DL95X, KK95X	95 to 265 Keys

Special Order Only

©ZIPF LOCK COMPANY

KEY CABINETS

Single Tag



HPC's single-tag key security control system is designed to control and provide security for 8 to 730 keys. KEKABS are ideal for home, store, or office use, where centralized or departmental key control is desired. They are designed to be mounted on a wall, near a desk, or a workstation.

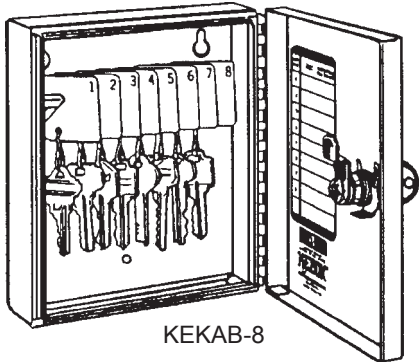

KEKAB-8

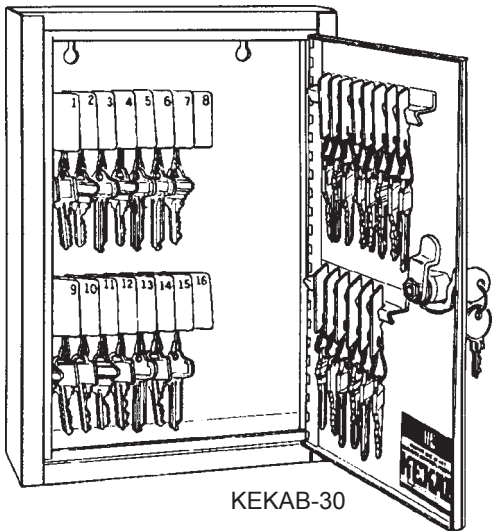

KEKAB-30

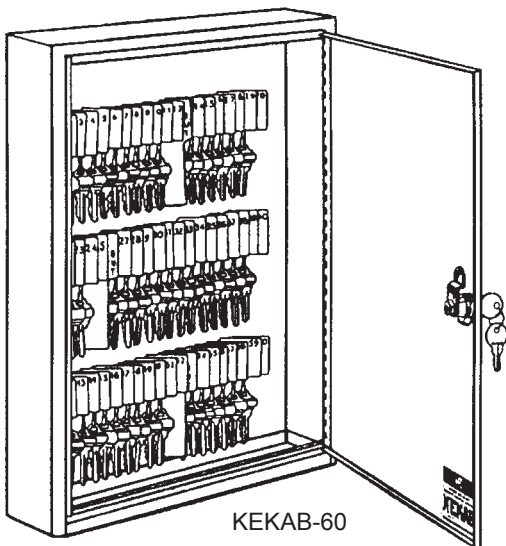

KEKAB-60

Each HPC KEKAB security control system includes:

- **White Plastic Key Tags** with bright nickel plated snap-hooks which can hold multiple keys on each snap-hook. The tags are numbered for easy identification.
- **Durable Steel Key Racks** that are slotted to store key tags uniformly for immediate identification.
- **"Out Key" Control Tags** that are made of yellow paper. They are used for accountability (to record information on loaned keys).
- **Lock Location Data** which consists of an erasable lock location chart as part of the KEKAB-8 and numbered key control booklets with all other KEKABS.
- **Unique Powder Coat Textured Painting Process** which provides an attractive and very durable finish. The neutral sand color allows them to be hung anywhere.
- **Heavy Gauge Steel Construction** with piano hinged doors and key panels provides a sturdy location to secure your keys.

Most Single-tag KEKABS are equipped with a 5 wafer tumbler lock with two keys. **KEKABS denoted with an asterisk (*) are equipped with a high security 7 pin tubular lock with popout T-handle.** All KEKABS can be keyed-alike, master-keyed or furnished with a combination lock or dual control locks at an additional charge (factory order). The "X" at the end of the stock number denotes that the cabinet is expandable.

<u>Stock No.</u>	<u>Capacity</u>	<u>Dimensions</u>
KEKAB-8	8 keys	6-5/8" x 5-3/4" x 2"
KEKAB-30	30 keys	12" x 8" x 2-1/2"
KEKAB-40	40 keys	12" x 8" x 2-1/2"
KEKAB-60	60 keys	17" x 13" x 3-1/4"
KEKAB-80	80 keys	17" x 13" x 3-1/4"
KEKAB-120	120 keys	17" x 13" x 3-1/4"
KEKAB-160X	160 keys	20" x 16-1/2" x 5"
KEKAB-240	240 keys	20" x 16-1/2" x 5"
* KEKAB-260X	260 keys	25-1/4" x 18" x 5-1/2"
KEKAB-330	330 keys	20" x 16-1/2" x 5"
* KEKAB-500	500 keys	25-1/4" x 18" x 5-1/2"
* KEKAB-730	730 keys	25-1/4" x 18" x 7"

EXPANSION LEAVES-When your key control needs grow, so can your system. Leaves are easy to install and come with all necessary hardware, numbered tags (to increase capacity number) and control chart.

<u>Stock No.</u>	<u>For Kekab:</u>	<u>Increase From</u>	
KEKAB-DA	DL95X, KK95X	95 to 265 Keys	<i>Special Order</i>
KEKAB-A	KEKAB-160X	160 to 330 Keys	
KEKAB-B	KEKAB-260X	260 to 500 Keys	

©ZIPF LOCK COMPANY

KEY CABINETS

Two-Tag



HPC's two-tag security key control system is designed to control and provide security for 30 to 500 keys. The two-tag system enables your to loan a key, while keeping a copy in the cabinet for emergency use. The two-tag KEKAB is designed to be mounted on a wall, near a desk, or a workstation.

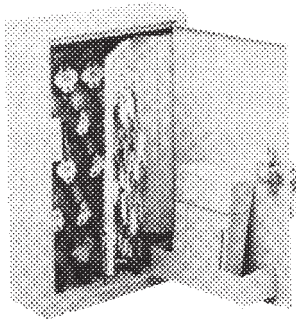

KEKAB-T30

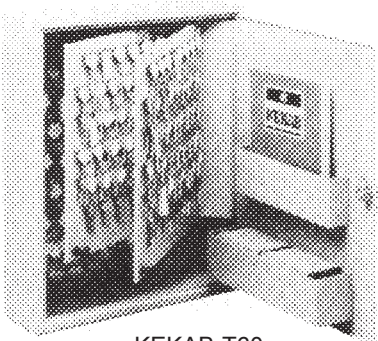

KEKAB-T60

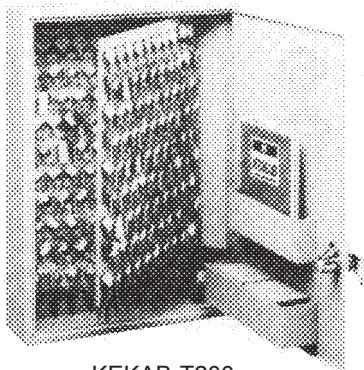

KEKAB-T200

Each HPC KEKAB II security control system includes:

- **Red Plastic Octagonal Permanent Key Tags** have self-locking key holder. This key tag is designed to hold the original key and remain in the KEKAB. The tags are numbered for easy identification.
- **White Plastic Cloverleaf Loaner Key Tags** are used to hold duplicates of the permanent key. The tags are numbered for easy identification.
- **Key Organization Sleeves** are for the collection of keys. These envelopes are pre-printed with room for pertinent information.
- **Key Receipt Slips** are designed to keep a record of keys loaned out. Personnel must fill out slips in order to obtain a key. The slip is then hung on the appropriate hook in the KEKAB in place of the loaned key.
- **Brass Receipt Holder** for optional use of holding key receipt slip on hook. (Complies with governmental regulations.)
- **Cross Reference Binder** contains three referencing methods for a detailed record of all keys. Includes complete key loan record, cross reference sheets and detailed instruction sheet.
- **Unique Powder Coat Textured Painting Process** provides an attractive and very durable finish on all KEKAB units. The neutral sand color allows them to be hung anywhere.
- **Heavy Gauge Steel Construction** with piano hinged doors and key panels provides a sturdy location to secure your keys.

All KEKAB II cabinets listed below are equipped with a 5 wafer tumbler cam lock and two keys. All KEKABS can be keyed-alike, master-keyed or furnished with a combination lock or dual control locks at an additional charge (factory order). The "X" at the end of the stock number denotes that the cabinet is expandable. **KEKABS denoted with an asterisk (*) are equipped with a high security 7 pin tubular lock with pop-out T-handle.**

<u>Stock No.</u>	<u>Capacity</u>	<u>Dimensions</u>
\$KEKAB-T30	30 keys	12" x 8" x 2-1/2"
\$KEKAB-T40X	40 keys	17" x 13" x 3-1/4"
KEKAB-T60	60 keys	17" x 13" x 3-1/4"
KEKAB-T80X	80 keys	20" x 16-1/2" x 5"
* \$KEKAB-T100X	100 keys	30" x 18" x 5-1/2"
\$KEKAB-T120X	120 keys	20" x 16-1/2" x 5"
\$KEKAB-T160X	160 keys	20" x 16-1/2" x 5"
\$KEKAB-T200	200 keys	20" x 16-1/2" x 5"
\$KEKAB-T240	240 keys	20" x 16-1/2" x 5"
* \$KEKAB-T300X	300 keys	30" x 18" x 5-1/2"
* \$KEKAB-T400	400 keys	30" x 18" x 5-1/2"
* \$KEKAB-T500	500 keys	30" x 18" x 5-1/2"

Keycabs marked with \$ are special order. Some in stock at close-out prices.

EXPANSION LEAVES-When your key control needs grow, so can your system. Leaves are easy to install and come with all necessary hardware, numbered tags (to increase capacity number) and control charts. **FACTORY ORDER.**

KEY CABINETS



SLIMKABS™

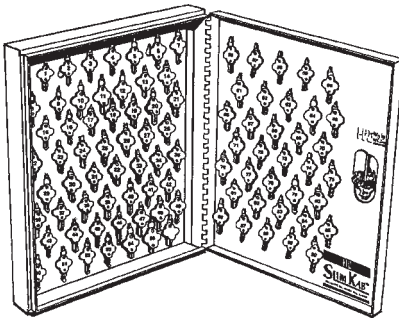

SlimKab™ — The SlimKab line is an economical line of key control cabinets. They are available in two expandable sizes (SK-55X is special order). The cabinets are made of 22 gauge steel and come equipped with a five wafer cam lock. They are painted in a neutral sand color. The hooks for the tags are a single prong style (made for standard rings). This enables you to use any key ring in the SlimKabs. The "X" at the end of a stock number denotes that the cabinet is expandable. The expansion leaves are factory order.

<u>Stock No.</u>	<u>Capacity</u>	<u>Dimensions</u>
SK-15X	15 keys	10-1/2" x 6" x 1-1/2"

MEDI-KAB™



\$MEDI-KAB 3
12" x 8" x 2-1/2"

\$-Discontinued. Call for closeout prices.

HPC's Medi-Kab offers the most secure location for medicine and pharmaceuticals. The welded construction is from the finest heavy gauge steel. The Medi-Kab also features a rugged piano hinged door for security purposes. All Medi-Kabs use a cam lock. These locks can be keyed alike or keyed differently to meet virtually any security requirement. Also available in Dual Control Locks (factory order)

The powder coat textured painting process is in a neutral sand color finish that is suitable for any decore, office or home. At the office, the MEDI-KAB is designed to be mounted on a wall, near a desk, or a work station. In the home the MEDI-KAB is designed to be used in the kitchen, bathroom or closet.

FIRE EXTINGUISHER CABINETS

HPC's Fire Extinguisher Cabinets are available in four sizes to fit the most popular sizes of fire extinguishers on the market. They are made of heavy gauge steel and painted in glossy white. The units are perfect for use in offices, warehouses, and hospitals. In the event that the fire extinguisher is needed, a hammer (that is attached to the top of the unit) is used to break the scored plexiglass on the front of the cabinet.

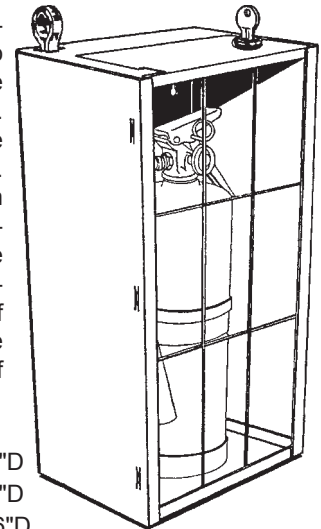

Discontinued-call for closeout prices

<u>Stock No.</u>	<u>Dimensions</u>
FXC-18	18"H x 8"W x 6"D
FXC-22	22"H x 8"W x 6"D
FXC-24	24"H x 10"W x 6"D
FXC-30	30"H x 12"W x 9"D

We do not sell fire extinguishers.

EMERGENCY KEY BOX

511 KA Keyed Alike
511 Glass Plexiglass Only
6-5/8"H x 5-3/4"W x 2"D
These boxes are designed to secure a restricted key at the immediate location. The bright red steel box has a key-locking hinged door with a plexiglass window. When an emergency arises and access to a specific key is necessary, break plexiglass with the attached hammer.

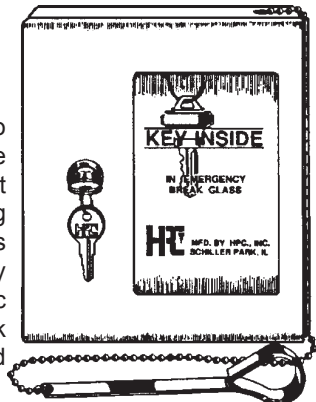

KEY CABINETS

KEKAB ACCESSORY TAGS

KEKAB Accessory Tags fits all KEKABS, Key boards, Key Racks, Carrying and Drawer KEKABS. The key tags are available numbered or plain.

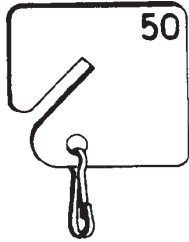

NT-1
NUMBERED TAGS
 with Snap Hooks
 Packed in series of 20 numbers;
 i.e., 1-20, 21-40, etc.
 We stock 1-20 thru 301-320.

SPECIFY numbers when ordering.

Ex: **NT-1 (41-60)**

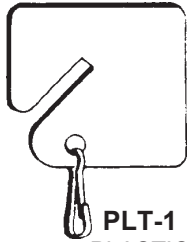

PLT-1
PLASTIC
PLAIN TAGS
 100 per box
 Sold by the box.

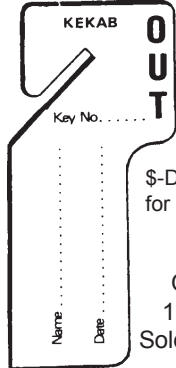

Yellow Paper

-\$-Discontinued-call for closeout prices

\$OT-100
OUT TAGS
 100 per pack
 Sold by the pack.



RECESSED CABINET FRAME

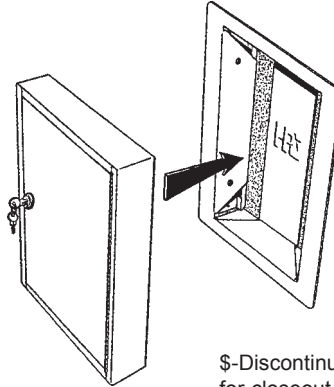

-\$-Discontinued-call for closeout prices

\$RCF-6

The Recessed Cabinet Frame (RCF-6) can be installed almost anywhere. It is for use with KEKAB-60, KEKAK-80, KEKAB-120, KEKAB-T40, KEKAB-T60, MEDI-KAB 6 and MEDI-KAB 6DC (units need to be drilled, using the frame as a template). The Recessed Cabinet Frame allows for the key control unit to be completely flush with the wall. The unit is made of heavy-gauge steel and painted in a neutral sand color. It is extremely easy to install, and the overlap lip of the frame allows for a margin of error when cutting. **KEY CABINETS SOLD SEPARATELY.**

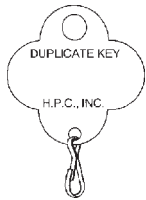

\$PLT-2T
PLAIN UN-NUMBERED
LOANER TAGS
 100 per box
 Sold by the box.

TWO-TAG KEKAB ACCESSORIES

-\$-Discontinued-call for closeout prices

\$OT-2T
OUT TAGS
 20 per envelope
 Sold by the envelope.

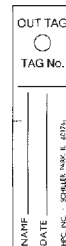

OVER DOOR KEY KEEPER™

No more lost keys or lockouts! Secure one key or several in the keeper. The box is placed over the top edge of the door. When the door is closed, the top mounting screws are hidden. It has a sturdy piano hinged door and is made of heavy gauge steel and has a glossy white finish. Box is furnished with a 7 pin tubular key lock and one key. Box Size: 3-1/4"H x 2-1/2"W x 2"D.

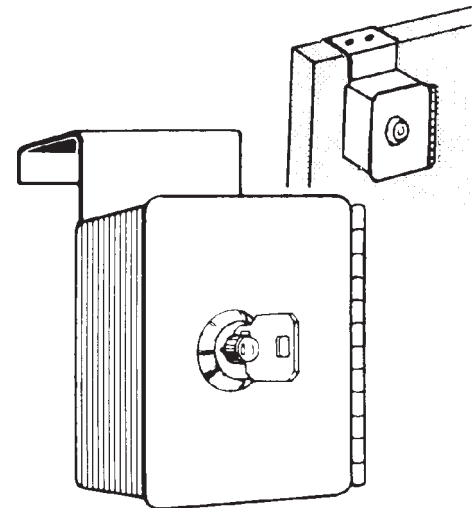

<u>Stock No.</u>	<u>Keyed Alike No.</u>
KEP-12-96	3396
\$KEP-12-97	3397

Furnished with one key per box.
 -\$-Discontinued. Call for closeout prices.

KEY CABINETS

HPC



MOUNT
UNDER
HOOD

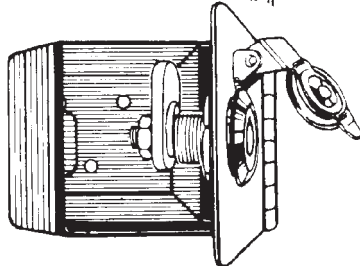
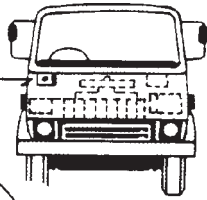

TRUCK KEY KEEPER™

For trucking firms and commercial truck fleets.

This key keeper is perfect for trucking firms and commercial truck fleets. The box made of heavy gauge steel, with a charcoal grey baked enamel finish.

It keeps keys secure within a truck, as well as eliminate loss of ignition keys for large fleets. HPC's Key Keeper is like a small bank vault. It mounts under the hood, onto an inside fender or body wall, with the three included sheet metal screws. Each keeper comes complete with a 7 pin tubular lock with dust cover and one key. Box Size: 3-1/2"H x 3-1/4"W x 1-1/2"D.

Stock No. **Keyed Alike No.**
KEP-16-95 3395
 Furnished with one key.



Single tag key cabinets are designed to secure and provide a secure centralized key control location for home, office, store and commercial locations. Key Cabinets are available in the most popular sizes, 10, 30, 60, 120 and 200 key capacities.

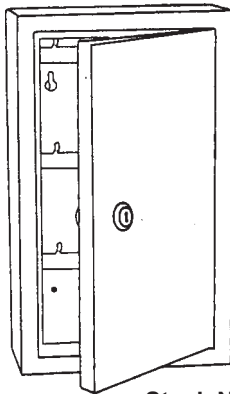

- Wall mounted design.
- Locking cabinets features ILCO® cam lock with two keys.
- Heavy gauge steel construction with welded, round corners.
- Sturdy continuous door hinge.
- Durable welded slotted steel key racks.
- Durable powder coat, neutral sand beige texture finish.
- White plastic, numbered single set key tags with nickel plated snap-hooks included (additional tags sold separately).
- Includes key control log.
- Each cabinet is packed in a consumer appealing box suitable for retail display. (English, Spanish and French)

Stock No.	Capacity	Width	Depth	Height	LBS
IL-KEY CABINET 10	10	7.1	2.0	6.7	2.43
IL-KEY CABINET 30	30	7.1	2.0	11.8	4.19
IL-KEY CABINET 60	60	13.4	3.9	19.3	12.13
IL-KEY CABINET 120	120	13.4	3.9	19.3	13.01
IL-KEY CABINET 200	200	16.5	5.1	20.1	17.42

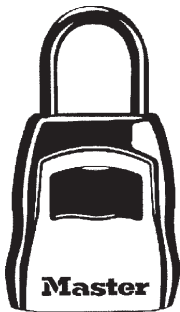

Portable
5400D



Wall Mount
5401D

SELECT ACCESS
Key Storage Security Program
 No Lockouts — No Schedule Conflicts

Master Lock.



Large key storage compartment—holds over 5 door or car keys. 4-dial resettable combination lock—provides simple, set-your-own combination convenience. Solid die cast body—reinforced to withstand hammering and sawing. Zinc lock body and shutter door—weather resistant for years of dependable operation.

©ZIPF LOCK COMPANY

KEY CABINETS

SHURLOK

- Never be locked out again.
- Patented feature-One combination opens the shackle and another combination opens key department.
- Secure-10,000 possible combinations.
- No front lid to fall off.
- Durable-all metal construction.
- Hardened steel shackle.
- Easier to use and recombine.
- Zero locking-can be opened in dark or by vision impaired.
- Rust resistant
- 1 year warranty.

<u>Stock No.</u>	<u>Description</u>
SL-200W BLACK	Box
SL-170	Lever grip

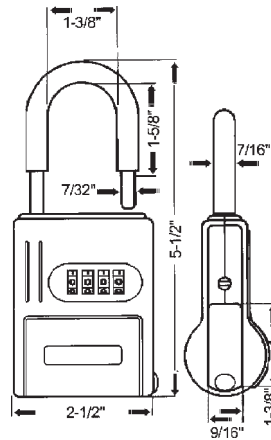

SUPRA



SR-000394 (C3) COMBINATION KEY BOX

All purpose removable KeyBox. User resettable combinations. DoorGuard rubber bumper protects surfaces. Three letter combination can be set to 17,000 different combinations. Easily attaches to door knobs, gates and railings.



SR-000404 (S5) COMBINATION KEY BOX

Surface mount unit. 4 screws provided. User resettable combinations. Three letter combination can be set to 17,000 different combinations. Rustproof and durable.



~~\$~~SR-000544 (C3-MORT) UNIVERSAL KEY BOX

~~\$~~-Discontinued. Call for closeout prices.

Easy to install and remove. Accepts 1-1/8" and 1-1/4" length mortise cylinders. DoorGuard rubber bumper protects surfaces. Uses standard Yale-type flat cam. Can be tied into master key systems.

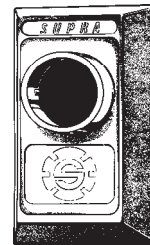

SR-000534 (M5) UNIVERSAL KEY BOX

Surface mounted unit. 4 screws provided. Accepts 1-1/8" and 1-1/4" length mortise cylinders. Ties into current master key systems.

KEY CABINETS



NOTE: KeyBox will open when the correct pushbuttons are pushed in any order.
EX: If set to 2785 you can also open with 8527, 2857, etc.

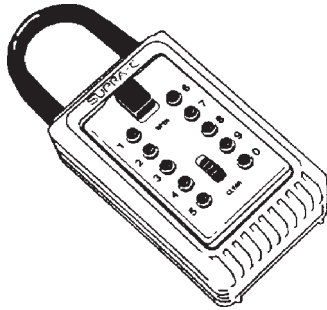

SR-001166 (C3 PUSH) PUSHBUTTON COMBINATION KEYBOX

User changeable pushbutton combo. Chrome plated. All purpose portable KeyBox with black DoorGuard® rubber bumper protects surfaces.

NOTE: KeyBox will open when the correct pushbuttons are pushed in any order.
EX: If set to 2785 you can also open with 8527, 2857, etc.

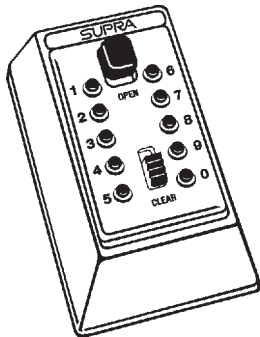

SR-001015 (S5 PUSH) PUSHBUTTON COMBINATION KEYBOX

User changeable pushbutton combo. Painted vault and lid. Surface mount: holds up to 5 keys.

INSIDE
DIMENSIONS:
3-5/8"H x 2-3/8"W
x 1-3/4"D

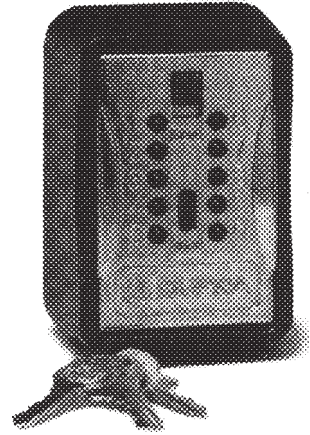

SR-001267 (S7) BIG BOX

Surface Mounted unit. Supra's new Big Box is a great addition to the STOR-A-KEY line of key storage items. Capitalizing on the popularity of the pushbutton lid, the Big Box is easy to use and offers these valuable features: Access cards easily fit into larger storage area; Accommodates multiple keys and bigger keys; Durable, recessed lid for tamper-resistance; Pushbutton technology makes combinations convenient to change.

NOTE: KeyBox will open when the correct pushbuttons are pushed in any order.

EX: If set to 2785 you can also open with 8527, 2857, etc.

SUPER HOOP

When doors can't handle a KeyBox !!

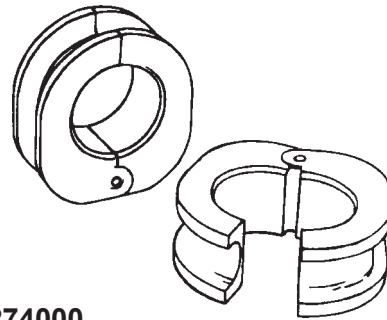

SR-274000 SUPER HOOP (sold as each)

The SuperHoop is an adapter that allows KeyBoxes to fit antique knobs, French Doors and Lever-style handles. SuperHoops have split-ring design for easy installation and feature a scuff-resistant finish that won't mar doors. Durable nylon thermoplastic construction fits smaller diameter locksets up to 27mm (1.06") x 19mm (.75").